

MITSUBOSHI

Pulley Products



Table of Contents

Product Code Key	Page 1
GigaTorque GX Timing Pulleys 8mm	Page 2
GigaTorque GX Timing Pulleys 14mm	Page 14
MXL Timing Pulleys	Page 22
XL Timing Pulleys	Page 29
L Timing Pulleys	Page 44
H Timing Pulleys	Page 59
T5 Timing Pulleys	Page 72
T10 Timing Pulleys	Page 75
AT5 Timing Pulleys	Page 79
AT10 Timing Pulleys	Page 82
J Section RIBSTAR Sheaves	Page 86
QD® Bushings	Page 89
TAPER-LOCK® Bushings	Page 90
H Series Timing Pulleys	Page 91
NOTES	Page 110

Note: QD is a registered trademark of TB WOODS, INC. TAPER-LOCK is a registered trademark of THE GATES® CORPORATION.

Product Code Key

<p>GigaTorque GX Timing Pulley</p> <p>22 8MX 12 1008</p> <p>No. of Pulley Teeth Belt Belt Width Bushing/Type*</p>	<p>MXL Timing Pulley</p> <p>10 MP 012 6CA1</p> <p>No. of Pulley Teeth Belt Belt Width Bushing/Type*</p>
<p>XL Timing Pulley</p> <p>10 XL 025 6FA2</p> <p>No. of Pulley Teeth Belt Belt Width Bushing/Type*</p>	<p>L Timing Pulley</p> <p>10 L 050 6FA5</p> <p>No. of Pulley Teeth Belt Belt Width Bushing/Type*</p>
<p>H Timing Pulley</p> <p>14 H 100 6FS7</p> <p>No. of Pulley Teeth Belt Belt Width Bushing/Type*</p>	<p>T5 Timing Pulley</p> <p>25 T5 / 10 - 2</p> <p>Overall Length Belt Type No. of Pulley Teeth No. of Flanges</p>
<p>T10 Timing Pulley</p> <p>31 T10 / 14 - 2</p> <p>Overall Length Belt Type No. of Pulley Teeth No. of Flanges</p>	<p>AT5 Timing Pulley</p> <p>21 AT5 / 12 - 2</p> <p>Overall Length Belt Type No. of Pulley Teeth No. of Flanges</p>
<p>AT10 Timing Pulley</p> <p>31 AT10 / 18 - 2</p> <p>Overall Length Belt Type No. of Pulley Teeth No. of Flanges</p>	<p>RIBSTAR Sheaves</p> <p>6 J 150 X 1/2</p> <p>No. of Ribs Belt Type Belt Width Bushing/Bore**</p>

* Bushing/Type refers to either Minimum Plain Bore or QD or Typer Lock Bushing.

** Bushing/Bore refers to either Finished Bore or QD Bushing.

GigaTorque GX TIMING PULLEYS

8 mm Pitch
For 12 mm Wide Belts
Hub and Flanges
Steel/Iron
Black Oxide Plating
Finished Bore



Note: Pulleys with bores 0.500" or less have set screws.
Pulleys with bores greater than 0.500" have keyways and set screws.

Part Number	No. of Teeth	Type	Pitch Dia. (in)	Out. Dia. (in)	Flange Dia. (in)	Bore (in)	Face Width (in)	Overall Length (in)	Set Screw
22-8MXF12X1/2	22	6F	2.206	2.143	2.559	0.500	0.850	1.313	2 x 10-32
22-8MXF12X5/8	22	6F	2.206	2.143	2.559	0.625	0.850	1.313	2 x 1/4-20
22-8MXF12X3/4	22	6F	2.206	2.143	2.559	0.750	0.850	1.313	2 x 1/4-20
22-8MXF12X7/8	22	6F	2.206	2.143	2.559	0.875	0.850	1.313	2 x 1/4-20
22-8MXF12X1	22	6F	2.206	2.143	2.559	1.000	0.850	1.313	2 x 5/16-18
22-8MXF12X1-1/8	22	6F	2.206	2.143	2.559	1.125	0.850	1.313	2 x 5/16-18
25-8MXF12X1/2	25	6F	2.506	2.443	2.950	0.500	0.850	1.313	2 x 10-32
25-8MXF12X5/8	25	6F	2.506	2.443	2.950	0.625	0.850	1.313	2 x 1/4-20
25-8MXF12X3/4	25	6F	2.506	2.443	2.950	0.750	0.850	1.313	2 x 1/4-20
25-8MXF12X7/8	25	6F	2.506	2.443	2.950	0.875	0.850	1.313	2 x 1/4-20
25-8MXF12X1	25	6F	2.506	2.443	2.950	1.000	0.850	1.313	2 x 5/16-18
25-8MXF12X1-1/8	25	6F	2.506	2.443	2.950	1.125	0.850	1.313	2 x 5/16-18
28-8MXF12X1/2	28	6F	2.807	2.744	3.150	0.500	0.850	1.313	2 x 10-32
28-8MXF12X5/8	28	6F	2.807	2.744	3.150	0.625	0.850	1.313	2 x 1/4-20
28-8MXF12X3/4	28	6F	2.807	2.744	3.150	0.750	0.850	1.313	2 x 1/4-20
28-8MXF12X7/8	28	6F	2.807	2.744	3.150	0.875	0.850	1.313	2 x 1/4-20
28-8MXF12X1	28	6F	2.807	2.744	3.150	1.000	0.850	1.313	2 x 5/16-18
28-8MXF12X1-1/8	28	6F	2.807	2.744	3.150	1.125	0.850	1.313	2 x 5/16-18
30-8MXF12X1/2	30	6F	3.008	2.945	3.350	0.500	0.850	1.422	2 x 10-32
30-8MXF12X5/8	30	6F	3.008	2.945	3.350	0.625	0.850	1.422	2 x 1/4-20
30-8MXF12X3/4	30	6F	3.008	2.945	3.350	0.750	0.850	1.422	2 x 1/4-20
30-8MXF12X7/8	30	6F	3.008	2.945	3.350	0.875	0.850	1.422	2 x 1/4-20
30-8MXF12X1	30	6F	3.008	2.945	3.350	1.000	0.850	1.422	2 x 5/16-18
30-8MXF12X1-1/8	30	6F	3.008	2.945	3.350	1.125	0.850	1.422	2 x 5/16-18
30-8MXF12X1-1/4	30	6F	3.008	2.945	3.350	1.250	0.850	1.422	2 x 5/16-18
32-8MXF12X1/2	32	6F	3.208	3.145	3.540	0.500	0.850	1.422	2 x 10-32
32-8MXF12X5/8	32	6F	3.208	3.145	3.540	0.625	0.850	1.422	2 x 1/4-20
32-8MXF12X3/4	32	6F	3.208	3.145	3.540	0.750	0.850	1.422	2 x 1/4-20
32-8MXF12X7/8	32	6F	3.208	3.145	3.540	0.875	0.850	1.422	2 x 1/4-20
32-8MXF12X1	32	6F	3.208	3.145	3.540	1.000	0.850	1.422	2 x 5/16-18
32-8MXF12X1-1/8	32	6F	3.208	3.145	3.540	1.125	0.850	1.422	2 x 5/16-18
32-8MXF12X1-1/4	32	6F	3.208	3.145	3.540	1.250	0.850	1.422	2 x 5/16-18

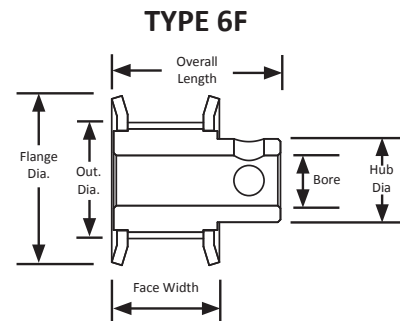

GigaTorque GX TIMING PULLEYS

8 mm Pitch

For 12 mm Wide Belts

Flanges

Steel/Iron

Black Oxide Plating

Minimum Plain Bore/Taper-Lock® Style



Part Number	No. of Teeth	Type	Pitch Dia. (in)	Out. Dia. (in)	Flange Dia. (in)	Bore/Bushing	Face Width (in)	Overall Length (in)
22-8MX12-1008	22	A1F	2.206	2.143	2.559	1008	0.875	0.875
22-8MX12-6FS6	22	6F	2.206	2.143	2.559	0.500	0.850	1.313
25-8MX12-1108	25	A1F	2.506	2.443	2.953	1108	0.875	0.875
25-8MX12-6FS6	25	6F	2.506	2.443	2.953	0.500	0.850	1.313
26-8MX12-1108	26	A1F	2.607	2.544	2.953	1108	0.875	0.875
27-8MX12-1108	27	A1F	2.707	2.644	3.150	1108	0.875	0.875
28-8MX12-1108	28	A1F	2.807	2.744	3.150	1108	0.875	0.875
28-8MX12-6FS6	28	6F	2.807	2.744	3.150	0.500	0.850	1.313
29-8MX12-1108	29	A1F	2.907	2.844	3.346	1108	0.875	0.875
30-8MX12-1108	30	A1F	3.008	2.945	3.346	1108	0.875	0.875
30-8MX12-6FS6	30	6F	3.008	2.945	3.346	0.500	0.850	1.422
31-8MX12-1210	31	A1F	3.108	3.045	3.543	1210	1.000	1.000
32-8MX12-1210	32	A1F	3.208	3.145	3.543	1210	1.000	1.000
32-8MX12-6FS6	32	6F	3.208	3.145	3.543	0.500	0.850	1.422
33-8MX12-1610	33	A1F	3.308	3.245	3.819	1610	1.000	1.000
34-8MX12-1610	34	A1F	3.409	3.346	3.819	1610	1.000	1.000
35-8MX12-1610	25	A1F	3.509	3.446	3.938	1610	1.000	1.000
36-8MX12-1610	36	A1F	3.609	3.546	3.938	1610	1.000	1.000

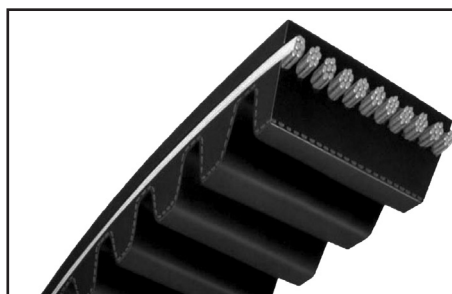
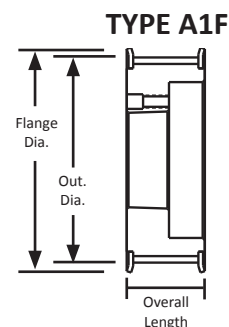
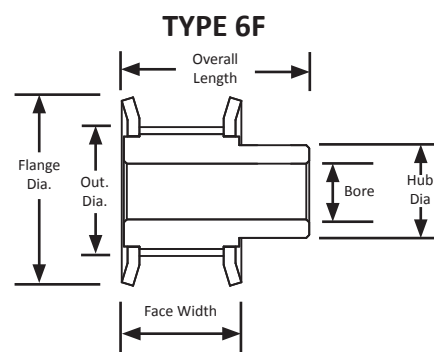

For matching GX pitch belts, see our
GigaTorque GX Brochure.

GigaTorque GX TIMING PULLEYS

8 mm Pitch
For 12 mm Wide Belts
Flanges
Steel/Iron
Black Oxide Plating
Taper-Lock® Style



Part Number	No. of Teeth	Type	Pitch Dia. (in)	Out. Dia. (in)	Flange Dia. (in)	Bore/Bushing	Face Width (in)	Overall Length (in)
37-8MX12-1610	37	A1F	3.709	3.646	4.156	1610	1.000	1.000
38-8MX12-1610	38	A1F	3.810	3.747	4.156	1610	1.000	1.000
39-8MX12-1610	39	A1F	3.910	3.847	4.331	1610	1.000	1.000
40-8MX12-2012	40	B1F	4.010	3.947	4.331	2012	0.850	1.250
41-8MX12-2012	41	B1F	4.110	4.047	4.331	2012	0.850	1.250
42-8MX12-2012	42	B1F	4.211	4.148	4.687	2012	0.850	1.250
45-8MX12-2012	45	B1F	4.511	4.448	5.005	2012	0.850	1.250
48-8MX12-2012	48	B1F	4.812	4.749	5.157	2012	0.850	1.250
50-8MX12-2012	50	B1F	5.013	4.950	5.320	2012	0.850	1.250
53-8MX12-2012	53	B1F	5.314	5.251	5.625	2012	0.850	1.250
56-8MX12-2012	56	B1F	5.614	5.551	5.945	2012	0.850	1.250
60-8MX12-2012	60	B1F	6.015	5.952	6.375	2012	0.850	1.250
63-8MX12-2012	63	C1F	6.316	6.253	6.772	2012	0.850	1.250
67-8MX12-2012	67	C1F	6.717	6.654	7.231	2012	0.850	1.250
71-8MX12-2012	71	C1F	7.118	7.055	7.575	2012	0.850	1.250
72-8MX12-2012	72	C1F	7.218	7.155	7.575	2012	0.850	1.250
75-8MX12-2012	75	C1F	7.519	7.456	7.867	2012	0.850	1.250
80-8MX12-2012	80	C1F	8.020	7.957	8.386	2012	0.850	1.250
90-8MX12-2012	90	C2	9.023	8.960	-	2012	0.850	1.250
112-8MX12-2012	112	C2	11.229	11.166	-	2012	0.850	1.250
140-8MX12-2012	140	C2	14.036	13.973	-	2012	0.850	1.250
180-8MX12-2517	180	C2	18.046	17.983	-	2517	0.850	1.750
224-8MX12-2517	224	C3	22.457	22.394	-	2517	0.850	1.750

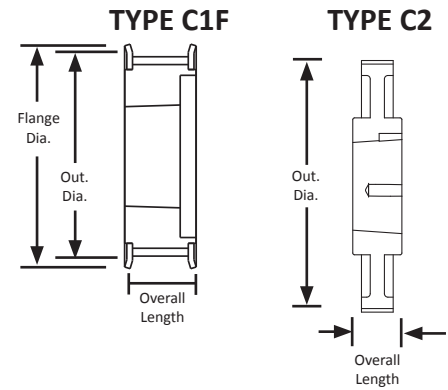
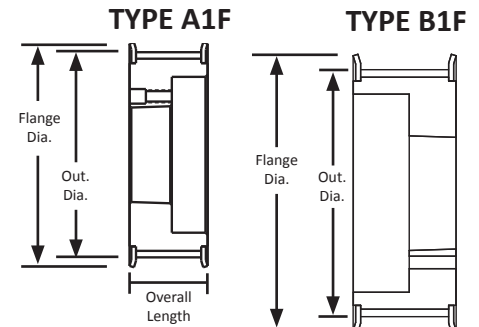

TYPE C3

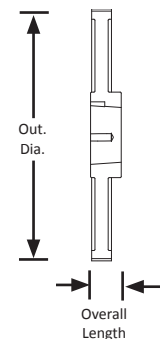

GigaTorque GX TIMING PULLEYS

**8 mm Pitch
For 21 mm Wide Belts
Hub and Flanges
Steel/Iron
Black Oxide Plating
Finished Bore**



Part Number	No. of Teeth	Type	Pitch Dia. (in)	Out. Dia. (in)	Flange Dia. (in)	Bore/ Bushing	Face Width (in)	Overall Length (in)
22-8MX21-6FS6	22	6F	2.206	2.143	2.559	0.500	1.203	1.656
25-8MX21-6FS6	25	6F	2.506	2.443	2.953	0.500	1.203	1.656
28-8MX21-6FS6	28	6F	2.807	2.744	3.150	0.500	1.203	1.656
30-8MX21-6FS6	30	6F	3.008	2.945	3.346	0.500	1.203	1.766
32-8MX21-6FS6	32	6F	3.208	3.145	3.543	0.500	1.203	1.766

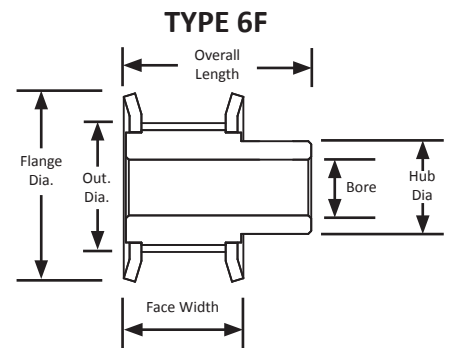

Part Number	No. of Teeth	Type	Pitch Dia. (in)	Out. Dia. (in)	Flange Dia. (in)	Bore (in)	Face Width (in)	Overall Length (in)	Set Screw
32-8MXF21x1/2	32	6F	3.208	3.145	3.540	0.500	1.203	1.766	2 x 10-32
32-8MXF21x5/8	32	6F	3.208	3.145	3.540	0.625	1.203	1.766	2 x 1/4-20
32-8MXF21x3/4	32	6F	3.208	3.145	3.540	0.750	1.203	1.766	2 x 1/4-20
32-8MXF21x7/8	32	6F	3.208	3.145	3.540	0.875	1.203	1.766	2 x 1/4-20
32-8MXF21x1	32	6F	3.208	3.145	3.540	1.000	1.203	1.766	2 x 5/16-18
32-8MXF21x1-1/8	32	6F	3.208	3.145	3.540	1.125	1.203	1.766	2 x 5/16-18
32-8MXF21x1-1/4	32	6F	3.208	3.145	3.540	1.250	1.203	1.766	2 x 5/16-18
32-8MXF21x1-3/8	32	6F	3.208	3.145	3.540	1.375	1.203	1.766	2 x 3/8-16

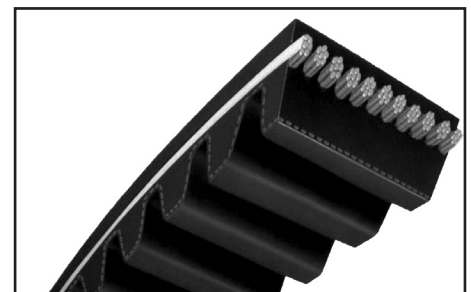

For matching GX pitch belts, see our GigaTorque GX Brochure.

Mitsubishi's GigaTorque GX timing belt is a high modulus but high flexibility carbon cord belt. This belt can help to minimize space, weight, and noise of machinery and equipment by applying narrower belt width compared to a regular timing belt. This belt can be applied for the applicability of chain drive systems.

GigaTorque GX TIMING PULLEYS

**8 mm Pitch
For 21 mm Wide Belts
Hub and Flanges
Steel/Iron
Black Oxide Plating
Finished Bore**



Note: Pulleys with bores 0.500" or less have set screws.
Pulleys with bores greater than 0.500" have keyways and set screws.

Part Number	No. of Teeth	Type	Pitch Dia. (in)	Out. Dia. (in)	Flange Dia. (in)	Bore (in)	Face Width (in)	Overall Length (in)	Set Screw
22-8MXF21X1/2	22	6F	2.206	2.143	2.560	0.500	1.203	1.656	2 x 10-32
22-8MXF21X5/8	22	6F	2.206	2.143	2.560	0.625	1.203	1.656	2 x 1/4-20
22-8MXF21X3/4	22	6F	2.206	2.143	2.560	0.750	1.203	1.656	2 x 1/4-20
22-8MXF21X7/8	22	6F	2.206	2.143	2.560	0.875	1.203	1.656	2 x 1/4-20
22-8MXF21X1	22	6F	2.206	2.143	2.560	1.000	1.203	1.656	2 x 5/16-18
22-8MXF21X1-1/8	22	6F	2.206	2.143	2.560	1.125	1.203	1.656	2 x 5/16-18
25-8MXF21X1/2	25	6F	2.506	2.443	2.950	0.500	1.203	1.656	2 x 10-32
25-8MXF21X5/8	25	6F	2.506	2.443	2.950	0.625	1.203	1.656	2 x 1/4-20
25-8MXF21X3/4	25	6F	2.506	2.443	2.950	0.750	1.203	1.656	2 x 1/4-20
25-8MXF21X7/8	25	6F	2.506	2.443	2.950	0.875	1.203	1.656	2 x 1/4-20
25-8MXF21X1	25	6F	2.506	2.443	2.950	1.000	1.203	1.656	2 x 5/16-18
25-8MXF21X1-1/8	25	6F	2.506	2.443	2.950	1.125	1.203	1.656	2 x 5/16-18
25-8MXF21X1-1/4	25	6F	2.506	2.443	2.950	1.250	1.203	1.656	2 x 5/16-18
25-8MXF21X1-3/8	25	6F	2.506	2.443	2.950	1.375	1.203	1.656	2 x 3/8-16
28-8MXF21X1/2	28	6F	2.807	2.744	3.150	0.500	1.203	1.656	2 x 10-32
28-8MXF21X5/8	28	6F	2.807	2.744	3.150	0.625	1.203	1.656	2 x 1/4-20
28-8MXF21X3/4	28	6F	2.807	2.744	3.150	0.750	1.203	1.656	2 x 1/4-20
28-8MXF21X7/8	28	6F	2.807	2.744	3.150	0.875	1.203	1.656	2 x 1/4-20
28-8MXF21X1	28	6F	2.807	2.744	3.150	1.000	1.203	1.656	2 x 5/16-18
28-8MXF21X1-1/8	28	6F	2.807	2.744	3.150	1.125	1.203	1.656	2 x 5/16-18
28-8MXF21X1-1/4	28	6F	2.807	2.744	3.150	1.250	1.203	1.656	2 x 5/16-18
28-8MXF21X1-3/8	28	6F	2.807	2.744	3.150	1.375	1.203	1.656	2 x 3/8-16
30-8MXF21X1/2	30	6F	3.008	2.945	3.350	0.500	1.203	1.766	2 x 10-32
30-8MXF21X5/8	30	6F	3.008	2.945	3.350	0.625	1.203	1.766	2 x 1/4-20
30-8MXF21X3/4	30	6F	3.008	2.945	3.350	0.750	1.203	1.766	2 x 1/4-20
30-8MXF21X7/8	30	6F	3.008	2.945	3.350	0.875	1.203	1.766	2 x 1/4-20
30-8MXF21X1	30	6F	3.008	2.945	3.350	1.000	1.203	1.766	2 x 5/16-18
30-8MXF21X1-1/8	30	6F	3.008	2.945	3.350	1.125	1.203	1.766	2 x 5/16-18
30-8MXF21X1-1/4	30	6F	3.008	2.945	3.350	1.250	1.203	1.766	2 x 5/16-18
30-8MXF21X1-3/8	30	6F	3.008	2.945	3.350	1.375	1.203	1.766	2 x 3/8-16

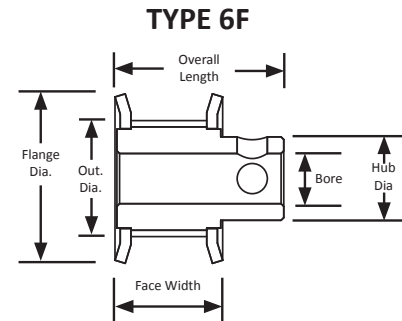

GigaTorque GX TIMING PULLEYS

8 mm Pitch
For 21 mm Wide Belts
Flanges
Steel/Iron
Black Oxide Plating
Taper-Lock® Style



Part Number	No. of Teeth	Type	Pitch Dia. (in)	Out. Dia. (in)	Flange Dia. (in)	Bushing	Face Width (in)	Overall Length (in)
22-8MX21-1008	22	A1F	2.206	2.143	2.559	1008	1.203	1.203
25-8MX21-1108	25	A1F	2.506	2.443	2.953	1108	1.203	1.203
26-8MX21-1108	26	A1F	2.607	2.544	2.953	1108	1.203	1.203
27-8MX21-1108	27	A1F	2.707	2.644	3.150	1108	1.203	1.203
28-8MX21-1108	28	A1F	2.807	2.744	3.150	1108	1.203	1.203
29-8MX21-1108	29	A1F	2.907	2.844	3.346	1108	1.203	1.203
30-8MX21-1108	30	A1F	3.008	2.945	3.346	1108	1.203	1.203
31-8MX21-1210	31	A1F	3.108	3.045	3.543	1210	1.203	1.203
32-8MX21-1210	32	A1F	3.208	3.145	3.543	1210	1.203	1.203
33-8MX21-1610	33	A1F	3.308	3.245	3.819	1610	1.203	1.203
34-8MX21-1610	34	A1F	3.409	3.346	3.819	1610	1.203	1.203
35-8MX21-1610	35	A1F	3.509	3.446	3.938	1610	1.203	1.203
36-8MX21-1610	36	A1F	3.609	3.546	3.938	1610	1.203	1.203
37-8MX21-1610	37	A1F	3.709	3.646	4.156	1610	1.203	1.203
38-8MX21-1610	38	A1F	3.810	3.747	4.156	1610	1.203	1.203
39-8MX21-1610	39	A1F	3.910	3.847	4.331	1610	1.203	1.203
40-8MX21-2012	40	A1F	4.010	3.947	4.331	2012	1.250	1.250
41-8MX21-2012	41	A1F	4.110	4.047	4.331	2012	1.250	1.250
42-8MX21-2012	42	A1F	4.211	4.148	4.687	2012	1.250	1.250
45-8MX21-2012	45	A1F	4.511	4.448	5.005	2012	1.250	1.250
48-8MX21-2012	48	A1F	4.812	4.749	5.157	2012	1.250	1.250
50-8MX21-2012	50	A1F	5.013	4.950	5.320	2012	1.250	1.250
53-8MX21-2012	53	A1F	5.314	5.251	5.625	2012	1.250	1.250
56-8MX21-2012	56	A1F	5.614	5.551	5.945	2012	1.250	1.250
60-8MX21-2012	60	A1F	6.015	5.952	6.375	2012	1.250	1.250
63-8MX21-2012	63	C1F	6.316	6.253	6.772	2012	1.203	1.250
67-8MX21-2517	67	C1F	6.717	6.654	7.231	2517	1.203	1.750
71-8MX21-2517	71	C1F	7.118	7.055	7.575	2517	1.203	1.750
72-8MX21-2517	72	C1F	7.218	7.155	7.575	2517	1.203	1.750
75-8MX21-2517	75	C1F	7.519	7.456	7.867	2517	1.203	1.750
80-8MX21-2517	80	C1F	8.020	7.957	8.386	2517	1.203	1.750
90-8MX21-2517	90	C2	9.023	8.960	-	2517	1.203	1.750
112-8MX21-2517	112	C2	11.229	11.166	-	2517	1.203	1.750
140-8MX21-2517	140	C3	14.036	13.973	-	2517	1.203	1.750
180-8MX21-2517	180	C3	18.046	17.983	-	3020	1.203	2.000
224-8MX21-3020	224	C3	22.457	22.394	-	3020	1.203	2.000

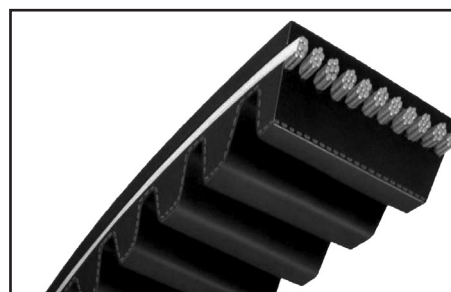
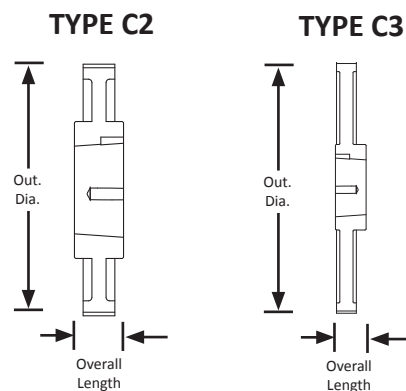
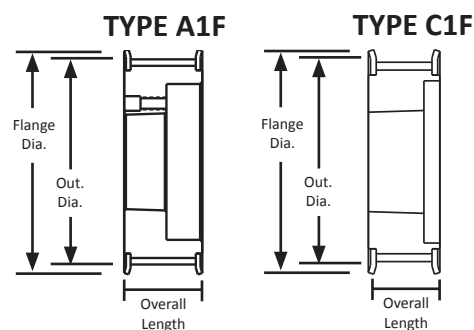

For matching GX pitch belts, see our
GigaTorque GX Brochure.

GigaTorque GX TIMING PULLEYS

8 mm Pitch
For 36 mm Wide Belts
Steel/Iron
Black Oxide Plating
Minimum Plain Bore/Taper-Lock



Part Number	No. of Teeth	Type	Pitch Dia. (in)	Out. Dia. (in)	Flange Dia. (in)	Bore/Bushing	Face Width (in)	Overall Length (in)
22-8MX36-6FS6	22	6F	2.206	2.143	2.559	0.500	1.859	2.438
25-8MX36-6FS6	25	6F	2.506	2.443	2.953	0.500	1.859	2.438
28-8MX36-6FS6	28	6F	2.807	2.744	3.150	0.500	1.859	2.438
30-8MX36-6FS6	30	6F	3.008	2.945	3.346	0.500	1.859	2.438
32-8MX36-1210	32	A1F	3.208	3.145	3.543	1210	1.859	1.859
32-8MX36-6FS6	32	6F	3.208	3.145	3.543	0.500	1.859	2.438
33-8MX36-1610	33	A1F	3.308	3.245	3.819	1610	1.859	1.859
34-8MX36-1610	34	A1F	3.409	3.346	3.819	1610	1.859	1.859
34-8MX36-6FS6	34	6F	3.409	3.346	3.819	0.500	1.859	2.453
35-8MX36-1610	35	A1F	3.509	3.446	3.938	1610	1.859	1.859
36-8MX36-1610	36	A1F	3.609	3.546	3.938	1610	1.859	1.859
36-8MX36-6FS6	36	6F	3.609	3.546	3.938	0.500	1.859	2.516
37-8MX36-1610	37	A1F	3.709	3.646	4.156	1610	1.859	1.859
38-8MX36-1610	38	A1F	3.810	3.747	4.156	1610	1.859	1.859
38-8MX36-6FS6	38	6F	3.810	3.747	4.156	0.500	1.859	2.516
39-8MX36-1610	39	A1F	3.910	3.847	4.331	1610	1.859	1.859
40-8MX36-2012	40	A1F	4.010	3.947	4.331	2012	1.859	1.859
41-8MX36-2012	41	A1F	4.110	4.047	4.331	2012	1.859	1.859
42-8MX36-2012	42	A1F	4.211	4.148	4.687	2012	1.859	1.859
45-8MX36-2012	45	A1F	4.511	4.448	5.005	2012	1.859	1.859
48-8MX36-2012	48	A1F	4.812	4.749	5.157	2012	1.859	1.859
50-8MX36-2012	50	A1F	5.013	4.950	5.320	2012	1.859	1.859
53-8MX36-2012	53	A1F	5.314	5.251	5.625	2012	1.859	1.859
56-8MX36-2012	56	A1F	5.614	5.551	5.945	2012	1.859	1.859
60-8MX36-2517	60	A1F	6.015	5.952	6.375	2517	1.859	1.859
63-8MX36-2517	63	A1F	6.316	6.253	6.772	2517	1.859	1.859
67-8MX36-2517	67	D1F	6.717	6.654	7.231	2517	1.859	1.859
71-8MX36-2517	71	D1F	7.118	7.055	7.575	2517	1.859	1.859
75-8MX36-2517	75	D1F	7.519	7.456	7.867	2517	1.859	1.859
80-8MX36-3020	80	B1F	8.020	7.957	8.386	3020	1.859	2.000
90-8MX36-3020	90	B1	9.023	8.960	-	3020	1.859	2.000
112-8MX36-3020	112	C2	11.229	11.166	-	3020	1.859	2.000
140-8MX36-3020	140	C3	14.036	13.973	-	3020	1.859	2.000
180-8MX36-3020	180	C3	18.046	17.983	-	3020	1.859	2.000
224-8MX36-3525	224	C3	22.457	22.394	-	3525	1.859	2.500

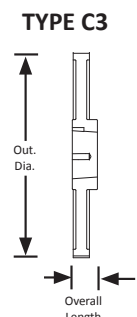
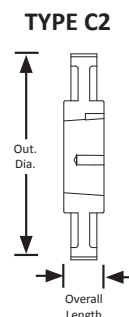
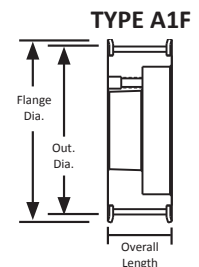
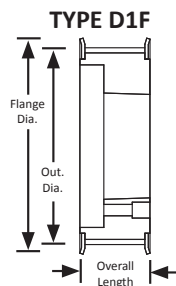
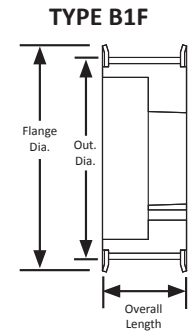
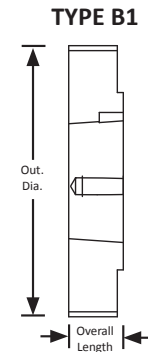
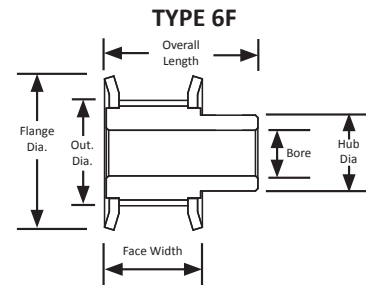

GigaTorque GX TIMING PULLEYS

8 mm Pitch
For 36 mm Wide Belts
Hub
Steel/Iron
Black Oxide Plating
Finished Bore



Note: Pulleys with bores 0.500" or less have set screws.
Pulleys with bores greater than 0.500" have keyways and set screws.

Part Number	No. of Teeth	Type	Pitch Dia. (in)	Out. Dia. (in)	Flange Dia. (in)	Bore (in)	Face Width (in)	Overall Length (in)	Set Screw
22-8MXF36X1/2	22	6F	2.206	2.143	2.560	0.500	1.859	2.438	2 x 10-32
22-8MXF36X5/8	22	6F	2.206	2.143	2.560	0.625	1.859	2.438	2 x 1/4-20
22-8MXF36X3/4	22	6F	2.206	2.143	2.560	0.750	1.859	2.438	2 x 1/4-20
22-8MXF36X7/8	22	6F	2.206	2.143	2.560	0.875	1.859	2.438	2 x 1/4-20
22-8MXF36X1	22	6F	2.206	2.143	2.560	1.000	1.859	2.438	2 x 5/16-18
22-8MXF36X1-1/8	22	6F	2.206	2.143	2.560	1.125	1.859	2.438	2 x 5/16-18
25-8MXF36X1/2	25	6F	2.506	2.443	2.950	0.500	1.859	2.438	2 x 10-32
25-8MXF36X5/8	25	6F	2.506	2.443	2.950	0.625	1.859	2.438	2 x 1/4-20
25-8MXF36X3/4	25	6F	2.506	2.443	2.950	0.750	1.859	2.438	2 x 1/4-20
25-8MXF36X7/8	25	6F	2.506	2.443	2.950	0.875	1.859	2.438	2 x 1/4-20
25-8MXF36X1	25	6F	2.506	2.443	2.950	1.000	1.859	2.438	2 x 5/16-18
25-8MXF36X1-1/8	25	6F	2.506	2.443	2.950	1.125	1.859	2.438	2 x 5/16-18
25-8MXF36X1-1/4	25	6F	2.506	2.443	2.950	1.250	1.859	2.438	2 x 5/16-18
25-8MXF36X1-3/8	25	6F	2.506	2.443	2.950	1.375	1.859	2.438	2 x 3/8-16
28-8MXF36X1/2	28	6F	2.807	2.744	3.150	0.500	1.859	2.438	2 x 10-32
28-8MXF36X5/8	28	6F	2.807	2.744	3.150	0.625	1.859	2.438	2 x 1/4-20
28-8MXF36X3/4	28	6F	2.807	2.744	3.150	0.750	1.859	2.438	2 x 1/4-20
28-8MXF36X7/8	28	6F	2.807	2.744	3.150	0.875	1.859	2.438	2 x 1/4-20
28-8MXF36X1	28	6F	2.807	2.744	3.150	1.000	1.859	2.438	2 x 5/16-18
28-8MXF36X1-1/8	28	6F	2.807	2.744	3.150	1.125	1.859	2.438	2 x 5/16-18
28-8MXF36X1-1/4	28	6F	2.807	2.744	3.150	1.250	1.859	2.438	2 x 5/16-18
28-8MXF36X1-3/8	28	6F	2.807	2.744	3.150	1.375	1.859	2.438	2 x 3/8-16
30-8MXF36X1/2	30	6F	3.008	2.945	3.350	0.500	1.859	2.438	2 x 10-32
30-8MXF36X5/8	30	6F	3.008	2.945	3.350	0.625	1.859	2.438	2 x 1/4-20
30-8MXF36X3/4	30	6F	3.008	2.945	3.350	0.750	1.859	2.438	2 x 1/4-20
30-8MXF36X7/8	30	6F	3.008	2.945	3.350	0.875	1.859	2.438	2 x 1/4-20
30-8MXF36X1	30	6F	3.008	2.945	3.350	1.000	1.859	2.438	2 x 5/16-18
30-8MXF36X1-1/8	30	6F	3.008	2.945	3.350	1.125	1.859	2.438	2 x 5/16-18
30-8MXF36X1-1/4	30	6F	3.008	2.945	3.350	1.250	1.859	2.438	2 x 5/16-18
30-8MXF36X1-3/8	30	6F	3.008	2.945	3.350	1.375	1.859	2.438	2 x 3/8-16

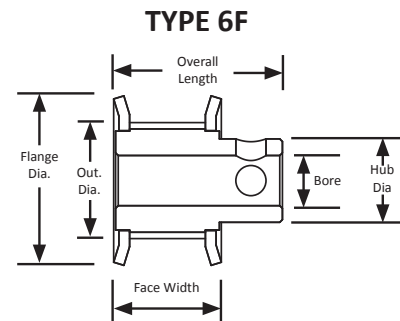

GigaTorque GX TIMING PULLEYS

8 mm Pitch
For 36 mm Wide Belts
Hub
Steel/Iron
Black Oxide Plating
Finished Bore



Note: Pulleys with bores 0.500" or less have set screws.
Pulleys with bores greater than 0.500" have keyways and set screws.

Part Number	No. of Teeth	Type	Pitch Dia. (in)	Out. Dia. (in)	Flange Dia. (in)	Bore (in)	Face Width (in)	Overall Length (in)	Set Screw
32-8MXF36X1/2	32	6F	3.208	3.145	3.540	0.500	1.859	2.438	2 x 10-32
32-8MXF36X5/8	32	6F	3.208	3.145	3.540	0.625	1.859	2.438	2 x 1/4-20
32-8MXF36X3/4	32	6F	3.208	3.145	3.540	0.750	1.859	2.438	2 x 1/4-20
32-8MXF36X7/8	32	6F	3.208	3.145	3.540	0.875	1.859	2.438	2 x 1/4-20
32-8MXF36X1	32	6F	3.208	3.145	3.540	1.000	1.859	2.438	2 x 5/16-18
32-8MXF36X1-1/8	32	6F	3.208	3.145	3.540	1.125	1.859	2.438	2 x 5/16-18
32-8MXF36X1-1/4	32	6F	3.208	3.145	3.540	1.250	1.859	2.438	2 x 5/16-18
32-8MXF36X1-3/8	32	6F	3.208	3.145	3.540	1.375	1.859	2.438	2 x 3/8-16
34-8MXF36X1/2	34	6F	3.409	3.346	3.820	0.500	1.859	2.438	2 x 10-32
34-8MXF36X5/8	34	6F	3.409	3.346	3.820	0.625	1.859	2.438	2 x 1/4-20
34-8MXF36X3/4	34	6F	3.409	3.346	3.820	0.750	1.859	2.438	2 x 1/4-20
34-8MXF36X7/8	34	6F	3.409	3.346	3.820	0.875	1.859	2.438	2 x 1/4-20
34-8MXF36X1	34	6F	3.409	3.346	3.820	1.000	1.859	2.438	2 x 5/16-18
34-8MXF36X1-1/8	34	6F	3.409	3.346	3.820	1.125	1.859	2.438	2 x 5/16-18
34-8MXF36X1-1/4	34	6F	3.409	3.346	3.820	1.250	1.859	2.438	2 x 5/16-18
34-8MXF36X1-3/8	34	6F	3.409	3.346	3.820	1.375	1.859	2.438	2 x 3/8-16
36-8MXF36X1/2	36	6F	3.609	3.546	3.940	0.500	1.859	2.516	2 x 10-32
36-8MXF36X5/8	36	6F	3.609	3.546	3.940	0.625	1.859	2.516	2 x 1/4-20
36-8MXF36X3/4	36	6F	3.609	3.546	3.940	0.750	1.859	2.516	2 x 1/4-20
36-8MXF36X7/8	36	6F	3.609	3.546	3.940	0.875	1.859	2.516	2 x 1/4-20
36-8MXF36X1	36	6F	3.609	3.546	3.940	1.000	1.859	2.516	2 x 5/16-18
36-8MXF36X1-1/8	36	6F	3.609	3.546	3.940	1.125	1.859	2.516	2 x 5/16-18
36-8MXF36X1-1/4	36	6F	3.609	3.546	3.940	1.250	1.859	2.516	2 x 5/16-18
36-8MXF36X1-3/8	36	6F	3.609	3.546	3.940	1.375	1.859	2.516	2 x 3/8-16
38-8MXF36X1/2	38	6F	3.810	3.747	4.160	0.500	1.859	2.516	2 x 10-32
38-8MXF36X5/8	38	6F	3.810	3.747	4.160	0.625	1.859	2.516	2 x 1/4-20
38-8MXF36X3/4	38	6F	3.810	3.747	4.160	0.750	1.859	2.516	2 x 1/4-20
38-8MXF36X7/8	38	6F	3.810	3.747	4.160	0.875	1.859	2.516	2 x 1/4-20
38-8MXF36X1	38	6F	3.810	3.747	4.16	1.000	1.859	2.516	2 x 5/16-18
38-8MXF36X1-1/8	38	6F	3.810	3.747	4.16	1.125	1.859	2.516	2 x 5/16-18
38-8MXF36X1-1/4	38	6F	3.810	3.747	4.16	1.250	1.859	2.516	2 x 5/16-18
38-8MXF36X1-3/8	38	6F	3.810	3.747	4.16	1.375	1.859	2.516	2 x 3/8-16

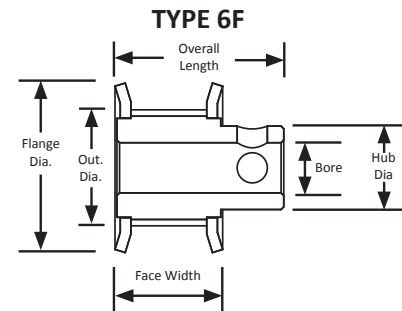

GigaTorque GX TIMING PULLEYS

8 mm Pitch

For 62 mm Wide Belts

Steel/Iron

Black Oxide Plating

Minimum Plain Bore/Taper-Lock



Part Number	No. of Teeth	Type	Pitch Dia. (in)	Out. Dia. (in)	Flange Dia. (in)	Bore/Bushing	Face Width (in)	Overall Length (in)
22-8MX62-6FS10	22	6F	2.206	2.143	2.559	1.000	2.906	3.563
25-8MX62-6FS10	25	6F	2.506	2.443	2.953	1.000	2.906	3.563
28-8MX62-6FS10	28	6F	2.807	2.744	3.150	1.000	2.906	3.563
30-8MX62-6FS10	30	6F	3.008	2.945	3.346	1.000	2.906	3.500
32-8MX62-6FS10	32	6F	3.208	3.145	3.543	1.000	2.906	3.500
34-8MX62-1610	34	A1F	3.409	3.346	3.819	1610	2.906	2.906
34-8MX62-6FS10	34	6F	3.409	3.346	3.819	1.000	2.906	3.500
36-8MX62-1610	36	A1F	3.609	3.546	3.938	1610	2.906	2.906
36-8MX62-6FS10	36	6F	3.609	3.546	3.938	1.000	2.906	3.563
38-8MX62-1610	38	A1F	3.810	3.747	4.156	1610	2.906	2.906
38-8MX62-6FS10	38	6F	3.810	3.747	4.156	1.000	2.906	3.563
40-8MX62-2012	40	A1F	4.010	3.947	4.331	2012	2.906	2.906
40-8MX62-6FS10	40	6F	4.010	3.947	4.331	1.000	2.906	3.625
42-8MX62-2012	42	A1F	4.211	4.148	4.687	2012	2.906	2.906
42-8MX62-6FS10	42	6F	4.211	4.148	4.687	1.000	2.906	3.625
45-8MX62-2012	45	A1F	4.511	4.448	5.005	2012	2.906	2.906
45-8MX62-6FS10	45	6F	4.511	4.448	5.005	1.000	2.906	3.625
48-8MX62-2517	48	A1F	4.812	4.749	5.157	2517	2.906	2.906
50-8MX62-2517	50	A1F	5.013	4.950	5.320	2517	2.906	2.906
53-8MX62-2517	53	A1F	5.314	5.251	5.625	2517	2.906	2.906
56-8MX62-2517	56	A1F	5.614	5.551	5.945	2517	2.906	2.906
60-8MX62-3020	60	A1F	6.015	5.952	6.375	3020	2.906	2.906
63-8MX62-3020	63	A1F	6.316	6.253	6.772	3020	2.906	2.906
67-8MX62-3020	67	A1F	6.717	6.654	7.231	3020	2.906	2.906
71-8MX62-3020	71	A1F	7.118	7.055	7.575	3020	2.906	2.906
75-8MX62-3020	75	A1F	7.519	7.456	7.867	3020	2.906	2.906
80-8MX62-3020	80	A1F	8.020	7.957	8.386	3020	2.906	2.906
90-8MX62-3020	90	D1	9.023	8.960	-	3020	2.906	2.906
112-8MX62-3020	112	D2	11.229	11.166	-	3020	2.906	2.906
140-8MX62-3525	140	D2	14.036	13.973	-	3525	2.906	2.906
180-8MX62-3525	180	D3	18.046	17.983	-	3525	2.906	2.906
224-8MX62-3525	224	D3	22.457	22.394	-	3525	2.906	2.906

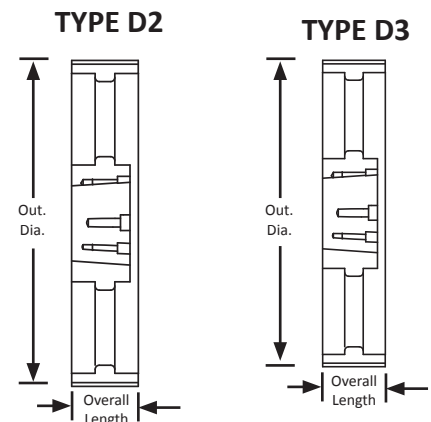
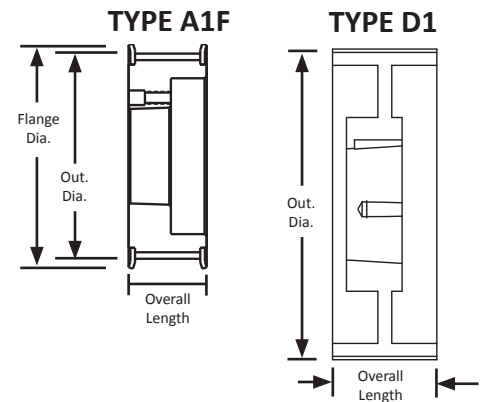
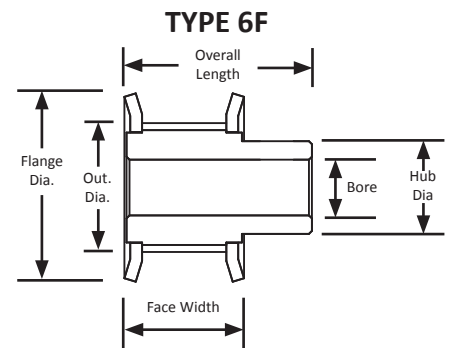

GigaTorque GX TIMING PULLEYS

8 mm Pitch
For 62 mm Wide Belts
Hub and Flanges
Steel/Iron
Black Oxide Plating
Finished Bore



Note: Pulleys with bores 0.500" or less have set screws.
Pulleys with bores greater than 0.500" have keyways and set screws.

Part Number	No. of Teeth	Type	Pitch Dia. (in)	Out. Dia. (in)	Flange Dia. (in)	Bore (in)	Face Width (in)	Overall Length (in)	Set Screw
22-8MXF62X1	22	6F	2.206	2.143	2.560	1.000	2.906	3.563	2 x 5/16-18
22-8MXF62X1-1/8	22	6F	2.206	2.143	2.560	1.125	2.906	3.563	2 x 5/16-18
25-8MXF62X1	25	6F	2.506	2.443	2.950	1.000	2.906	3.563	2 x 5/16-18
25-8MXF62X1-1/8	25	6F	2.506	2.443	2.950	1.125	2.906	3.563	2 x 5/16-18
25-8MXF62X1-1/4	25	6F	2.506	2.443	2.950	1.250	2.906	3.563	2 x 5/16-18
25-8MXF62X1-3/8	25	6F	2.506	2.443	2.950	1.375	2.906	3.563	2 x 3/8-16
28-8MXF62X1	28	6F	2.807	2.744	3.150	1.000	2.906	3.563	2 x 5/16-18
28-8MXF62X1-1/8	28	6F	2.807	2.744	3.150	1.125	2.906	3.563	2 x 5/16-18
28-8MXF62X1-1/4	28	6F	2.807	2.744	3.150	1.250	2.906	3.563	2 x 5/16-18
28-8MXF62X1-3/8	28	6F	2.807	2.744	3.150	1.375	2.906	3.563	2 x 3/8-16
30-8MXF62X1	30	6F	3.008	2.945	3.350	1.000	2.906	3.500	2 x 5/16-18
30-8MXF62X1-1/8	30	6F	3.008	2.945	3.350	1.125	2.906	3.500	2 x 5/16-18
30-8MXF62X1-1/4	30	6F	3.008	2.945	3.350	1.250	2.906	3.500	2 x 5/16-18
30-8MXF62X1-3/8	30	6F	3.008	2.945	3.350	1.375	2.906	3.500	2 x 3/8-16
32-8MXF62X1	32	6F	3.208	3.145	3.540	1.000	2.906	3.500	2 x 5/16-18
32-8MXF62X1-1/8	32	6F	3.208	3.145	3.540	1.125	2.906	3.500	2 x 5/16-18
32-8MXF62X1-1/4	32	6F	3.208	3.145	3.540	1.250	2.906	3.500	2 x 5/16-18
32-8MXF62X1-3/8	32	6F	3.208	3.145	3.540	1.375	2.906	3.500	2 x 3/8-16
34-8MXF62X1	34	6F	3.409	3.346	3.820	1.000	2.906	3.500	2 x 5/16-18
34-8MXF62X1-1/8	34	6F	3.409	3.346	3.820	1.125	2.906	3.500	2 x 5/16-18
34-8MXF62X1-1/4	34	6F	3.409	3.346	3.820	1.250	2.906	3.500	2 x 5/16-18
34-8MXF62X1-3/8	34	6F	3.409	3.346	3.820	1.375	2.906	3.500	2 x 3/8-16

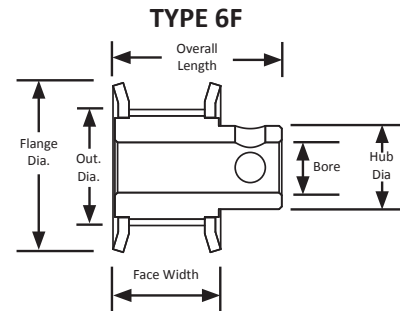

GigaTorque GX TIMING PULLEYS

8 mm Pitch
For 62 mm Wide Belts
Hub
Steel/Iron
Black Oxide Plating
Finished Bore



Note: Pulleys with bores 0.500" or less have set screws.
Pulleys with bores greater than 0.500" have keyways and set screws.

Part Number	No. of Teeth	Type	Pitch Dia. (in)	Out. Dia. (in)	Flange Dia. (in)	Bore (in)	Face Width (in)	Overall Length (in)	Set Screw
36-8MXF62X1	36	6F	3.609	3.546	3.940	1.000	2.906	3.563	2 x 5/16-18
36-8MXF62X1-1/8	36	6F	3.609	3.546	3.940	1.125	2.906	3.563	2 x 5/16-18
36-8MXF62X1-1/4	36	6F	3.609	3.546	3.940	1.250	2.906	3.563	2 x 5/16-18
36-8MXF62X1-3/8	36	6F	3.609	3.546	3.940	1.375	2.906	3.563	2 x 3/8-16
38-8MXF62X1	38	6F	3.810	3.747	4.160	1.000	2.906	3.563	2 x 5/16-18
38-8MXF62X1-1/8	38	6F	3.810	3.747	4.160	1.125	2.906	3.563	2 x 5/16-18
38-8MXF62X1-1/4	38	6F	3.810	3.747	4.160	1.250	2.906	3.563	2 x 5/16-18
38-8MXF62X1-3/8	38	6F	3.810	3.747	4.160	1.375	2.906	3.563	2 x 3/8-16
40-8MXF62X1	40	6F	4.010	3.947	4.330	1.000	2.906	3.625	2 x 5/16-18
40-8MXF62X1-1/8	40	6F	4.010	3.947	4.330	1.125	2.906	3.625	2 x 5/16-18
40-8MXF62X1-1/4	40	6F	4.010	3.947	4.330	1.250	2.906	3.625	2 x 5/16-18
40-8MXF62X1-3/8	40	6F	4.010	3.947	4.330	1.375	2.906	3.625	2 x 3/8-16
42-8MXF62X1	42	6F	4.211	4.148	4.690	1.000	2.906	3.625	2 x 5/16-18
42-8MXF62X1-1/8	42	6F	4.211	4.148	4.690	1.125	2.906	3.625	2 x 5/16-18
42-8MXF62X1-1/4	42	6F	4.211	4.148	4.690	1.250	2.906	3.625	2 x 5/16-18
42-8MXF62X1-3/8	42	6F	4.211	4.148	4.690	1.375	2.906	3.625	2 x 3/8-16
45-8MXF62X1	45	6F	4.511	4.448	5.010	1.000	2.906	3.625	2 x 5/16-18
45-8MXF62X1-1/8	45	6F	4.511	4.448	5.010	1.125	2.906	3.625	2 x 5/16-18
45-8MXF62X1-1/4	45	6F	4.511	4.448	5.010	1.250	2.906	3.625	2 x 5/16-18
45-8MXF62X1-3/8	45	6F	4.511	4.448	5.010	1.375	2.906	3.625	2 x 3/8-16

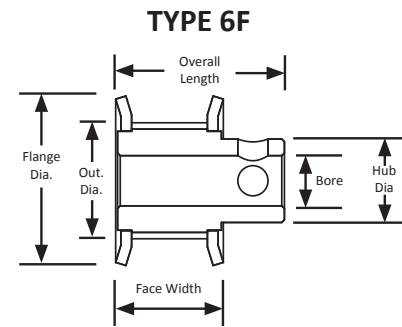

Black Oxide Advantages

Cost Effective

Corrosion Protection

Dimensional Stability

Lubricity

Abrasion Resistance

Decorative Finish

Reduced Light Glare

Pre-treatment for Paint

Conductivity

Surface Property Stability

No Embrittlement

No Welding Fumes

GigaTorque GX TIMING PULLEYS

**14 mm Pitch
For 20 mm Wide Belts
Iron
Black Oxide Plating
Taper-Lock® Style**



Part Number	No. of Teeth	Type	Pitch Dia. (in)	Out. Dia. (in)	Flange Dia. (in)	Bushing	Face Width (in)	Overall Length (in)
28-14MX20-2012	28	A1F	4.912	4.802	5.562	2012	1.359	1.359
29-14MX20-2012	29	A1F	5.088	4.978	5.562	2012	1.359	1.359
30-14MX20-2012	30	A1F	5.263	5.153	5.763	2012	1.359	1.359
31-14MX20-2012	31	A1F	5.439	5.329	6.124	2012	1.359	1.359
32-14MX20-2012	32	A1F	5.614	5.504	6.124	2012	1.359	1.359
33-14MX20-2012	33	A1F	5.790	5.680	6.465	2012	1.359	1.359
34-14MX20-2012	34	A1F	5.965	5.855	6.465	2012	1.359	1.359
35-14MX20-2012	35	A1F	6.141	6.031	6.816	2012	1.359	1.359
36-14MX20-2517	36	B1F	6.316	6.206	6.816	2517	1.359	1.750
37-14MX20-2517	37	B1F	6.492	6.382	7.167	2517	1.359	1.750
38-14MX20-2517	38	B1F	6.667	6.557	7.167	2517	1.359	1.750
39-14MX20-2517	39	B1F	6.842	6.732	7.518	2517	1.359	1.750
40-14MX20-2517	40	B1F	7.018	6.908	7.518	2517	1.359	1.750
43-14MX20-2517	43	B1F	7.544	7.434	8.395	2517	1.359	1.750
45-14MX20-3020	45	B1F	7.895	7.785	8.395	3020	1.359	2.000
48-14MX20-3020	48	B1F	8.421	8.311	8.941	3020	1.359	2.000
50-14MX20-3020	50	B1F	8.772	8.662	9.292	3020	1.359	2.000
53-14MX20-3020	53	B1F	9.299	9.189	9.687	3020	1.359	2.000
56-14MX20-3525	56	B1F	9.825	9.715	10.355	3525	1.359	2.500
60-14MX20-3525	60	B1F	10.527	10.417	11.067	3525	1.359	2.500
63-14MX20-3525	63	B1F	11.053	10.943	11.750	3525	1.359	2.500
67-14MX20-3525	67	B1F	11.755	11.645	12.500	3525	1.359	2.500
71-14MX20-3525	71	C1F	12.457	12.347	13.187	3525	1.359	2.500
75-14MX20-3525	75	C1F	13.158	13.048	13.730	3525	1.359	2.500
80-14MX20-3525	80	C2F	14.036	13.926	14.625	3525	1.359	2.500
90-14MX20-3525	90	C2	15.790	15.680	-	3525	1.359	2.500
112-14MX20-3525	112	C3	19.650	19.540	-	3525	1.359	2.500
126-14MX20-3525	126	C3	22.106	21.996	-	3525	1.359	2.500
140-14MX20-3525	140	C3	24.562	24.452	-	3525	1.359	2.500
154-14MX20-3525	154	C3	27.019	26.909	-	3525	1.359	2.500
168-14MX20-3525	168	C3	29.475	29.365	-	3525	1.359	2.500
180-14MX20-3525	180	C3	31.580	31.470	-	3525	1.359	2.500
200-14MX20-3525	200	C3	35.089	34.979	-	3525	1.359	2.500
224-14MX20-4030	224	C3	39.300	39.190	-	4030	1.359	3.000

TYPE A1F

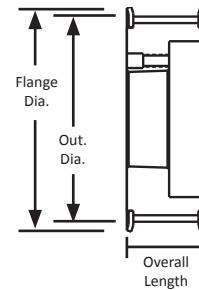

TYPE B1F

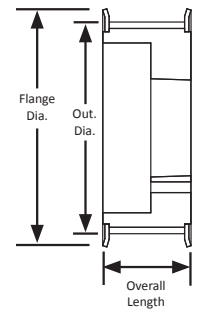

TYPE C1F

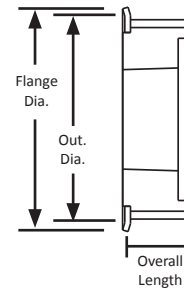

TYPE C2

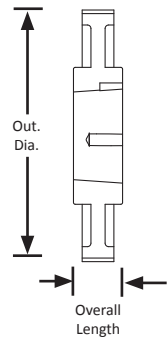

TYPE C2F

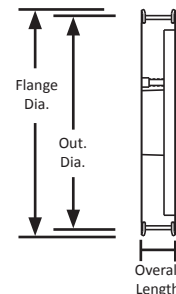

TYPE C3

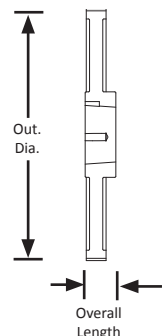

GigaTorque GX TIMING PULLEYS

14 mm Pitch
For 37 mm Wide Belts
Flanges
Iron
Black Oxide Plating
Minimum Plain Bore/Taper-Lock



Part Number	No. of Teeth	Type	Pitch Dia. (in)	Out. Dia. (in)	Flange Dia. (in)	Bore/Bushing	Face Width (in)	Overall Length (in)
28-14MX37-6FS10	28	6F	4.912	4.802	5.562	1.000	2.063	2.859
28-14MX37-2012	28	A1F	4.912	4.802	5.562	2012	1.690	2.000
29-14MX37-2517	29	A1F	5.088	4.978	5.562	2517	1.690	2.000
30-14MX37-2517	30	A1F	5.263	5.153	5.763	2517	1.690	2.000
31-14MX37-2517	31	A1F	5.439	5.329	6.124	2517	1.690	2.000
32-14MX37-2517	32	A1F	5.614	5.504	6.124	2517	1.690	2.000
33-14MX37-2517	33	A1F	5.790	5.680	6.465	2517	1.690	2.000
34-14MX37-2517	34	A1F	5.965	5.855	6.465	2517	1.690	2.000
35-14MX37-2517	35	A1F	6.141	6.031	6.816	2517	1.690	2.000
36-14MX37-2517	36	A1F	6.316	6.206	6.816	2517	1.690	2.000
37-14MX37-2517	37	A1F	6.492	6.382	7.167	2517	1.690	2.000
38-14MX37-3020	38	A1F	6.667	6.557	7.167	3020	1.750	2.063
39-14MX37-3020	39	A1F	6.842	6.732	7.518	3020	1.750	2.063
40-14MX37-3020	40	A1F	7.018	6.908	7.518	3020	1.750	2.063
43-14MX37-3020	43	A1F	7.544	7.434	8.395	3020	1.750	2.063
45-14MX37-3020	45	A1F	7.895	7.785	8.395	3020	1.750	2.063
48-14MX37-3020	48	A1F	8.421	8.311	8.941	3020	1.750	2.063
50-14MX37-3020	50	A1F	8.772	8.662	9.292	3020	1.750	2.063
53-14MX37-3020	53	A1F	9.299	9.189	9.687	3020	1.750	2.063
56-14MX37-3525	56	B1F	9.825	9.715	10.355	3525	2.063	2.500
60-14MX37-3525	60	B1F	10.527	10.417	11.067	3525	2.063	2.500
63-14MX37-3525	63	B1F	11.053	10.943	11.750	3525	2.063	2.500
67-14MX37-3525	67	B1F	11.755	11.645	12.500	3525	2.063	2.500
71-14MX37-3525	71	B1F	12.457	12.347	13.187	3525	2.063	2.500
75-14MX37-3525	75	C1F	13.158	13.048	13.730	3525	2.063	2.500
80-14MX37-3525	80	C2F	14.036	13.926	14.625	3525	2.063	2.500

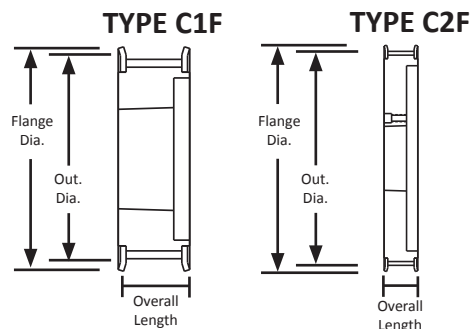
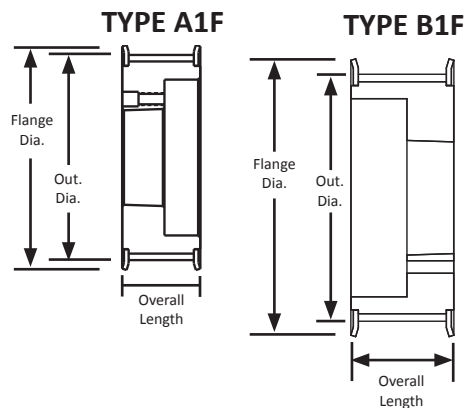
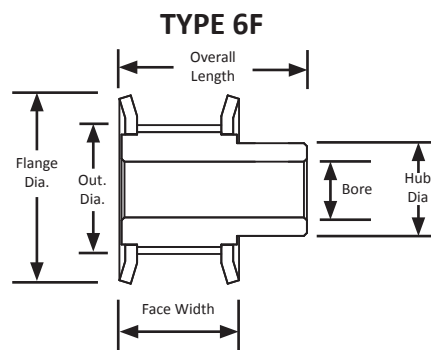

GigaTorque GX TIMING PULLEYS

14 mm Pitch
For 37 mm Wide Belts
Iron
Black Oxide Plating
Taper-Lock® Style



Part Number	No. of Teeth	Type	Pitch Dia. (in)	Out. Dia. (in)	Bushing	Face Width (in)	Overall Length (in)
90-14MX37-3525	90	C2	15.790	15.680	3525	2.063	2.500
112-14MX37-3525	112	C3	19.650	19.540	3525	2.063	2.500
126-14MX37-3525	126	C3	22.106	21.996	3525	2.063	2.500
140-14MX37-3525	140	C3	24.562	24.452	3525	2.063	2.500
154-14MX37-4030	154	C3	27.019	26.909	4030	2.063	2.500
168-14MX37-4030	168	C3	29.475	29.365	4030	2.063	3.000
180-14MX37-4030	180	C3	31.580	31.470	4030	2.063	3.000
200-14MX37-4030	200	C3	35.089	34.979	4030	2.063	3.000
224-14MX37-4030	224	C3	39.300	39.190	4030	2.063	3.000

TYPE C2

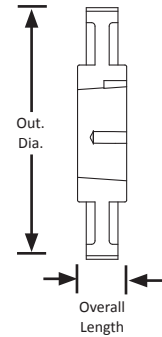

TYPE C3

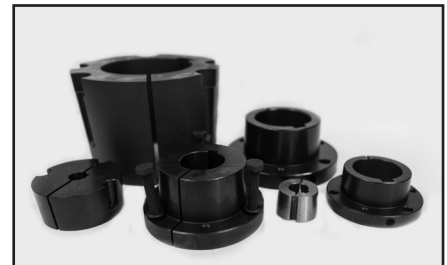
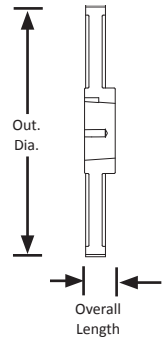

For matching Taper-Lock® bushings, see page 89.

PARALLEL MISALIGNMENT

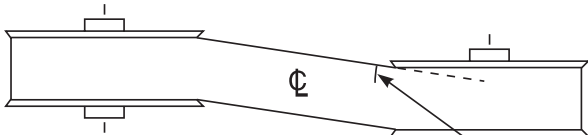

ANGULAR MISALIGNMENT

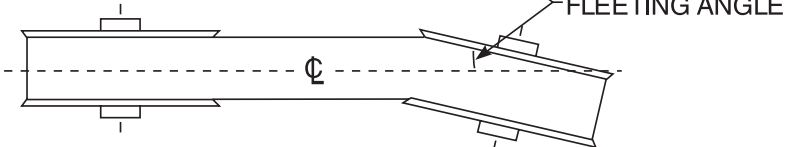

GigaTorque GX TIMING PULLEYS

14 mm Pitch
For 68 mm Wide Belts
Iron
Black Oxide Plating
Minimum Plain Bore/Taper-Lock



Part Number	No. of Teeth	Type	Pitch Dia. (in)	Out. Dia. (in)	Flange Dia. (in)	Bore/Bushing	Face Width (in)	Overall Length (in)
28-14MX68-6FS10	28	6F	4.912	4.802	5.562	1.000	3.328	4.125
29-14MX68-2517	29	A1F	5.088	4.978	5.562	2517	3.328	3.328
29-14MX68-6FS10	29	6F	5.088	4.978	5.562	1.000	3.328	4.125
30-14MX68-2517	30	A1F	5.263	5.153	5.763	2517	3.328	3.328
30-14MX68-6FS10	30	6F	5.263	5.153	5.763	1.000	3.328	4.125
31-14MX68-2517	31	A1F	5.439	5.329	6.124	2517	3.328	3.328
31-14MX68-6FS10	31	6F	5.439	5.329	6.124	1.000	3.328	4.125
32-14MX68-2517	32	A1F	5.614	5.504	6.124	2517	3.328	3.328
32-14MX68-6FS10	32	6F	5.614	5.504	6.124	1.000	3.328	4.125
33-14MX68-2517	33	A1F	5.790	5.680	6.465	2517	3.328	3.328
33-14MX68-6FS10	33	6F	5.790	5.680	6.465	1.000	3.328	4.328
34-14MX68-2517	34	A1F	5.965	5.855	6.465	2517	3.328	3.328
34-14MX68-6FS10	34	6F	5.965	5.855	6.465	1.000	3.328	4.328
35-14MX68-3020	35	A1F	6.141	6.031	6.816	3020	3.328	3.328
36-14MX68-3020	36	A1F	6.316	6.206	6.816	3020	3.328	3.328
37-14MX68-3020	37	A1F	6.492	6.382	7.167	3020	3.328	3.328
38-14MX68-3020	38	A1F	6.667	6.557	7.167	3020	3.328	3.328
39-14MX68-3020	39	A1F	6.842	6.732	7.518	3020	3.328	3.328
40-14MX68-3020	40	A1F	7.018	6.908	7.518	3020	3.328	3.328
43-14MX68-3020	43	A1F	7.544	7.434	8.395	3020	3.328	3.328
45-14MX68-3020	45	A1F	7.895	7.785	8.395	3020	3.328	3.328
48-14MX68-3525	48	A1F	8.421	8.311	8.941	3525	3.328	3.328
50-14MX68-3525	50	A1F	8.772	8.662	9.292	3525	3.328	3.328
53-14MX68-3525	53	A1F	9.299	9.189	9.687	3525	3.328	3.328
56-14MX68-3525	56	A1F	9.825	9.715	10.355	3525	3.328	3.328
60-14MX68-3525	60	A1F	10.527	10.417	11.067	3525	3.328	3.328
63-14MX68-3525	63	A1F	11.053	10.943	11.750	3525	3.328	3.328
67-14MX68-3525	67	D1F	11.755	11.645	12.500	3525	3.328	3.328
71-14MX68-3525	71	D1F	12.457	12.347	13.187	3525	3.328	3.328
75-14MX68-3525	75	D1F	13.158	13.048	13.730	3525	3.328	3.328

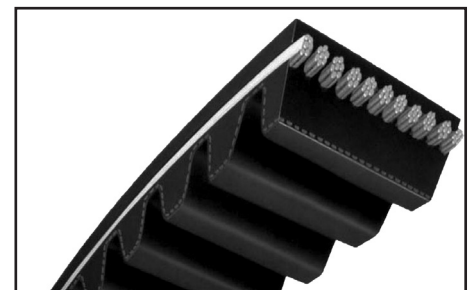
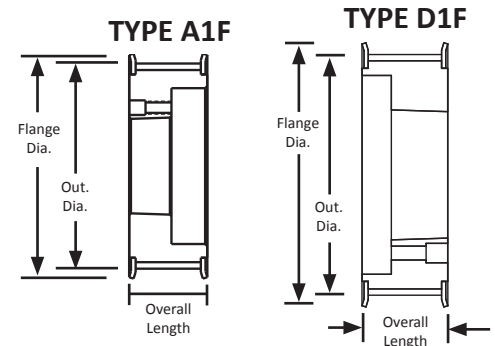
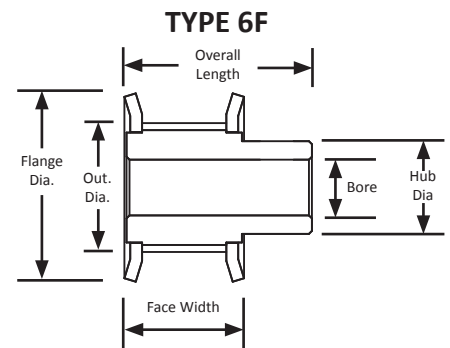

For matching GX pitch belts, see our
GigaTorque GX Brochure.

GigaTorque GX TIMING PULLEYS

14 mm Pitch
For 68 mm Wide Belts
Iron
Black Oxide Plating
Taper-Lock® Style



Part Number	No. of Teeth	Type	Pitch Dia. (in)	Out. Dia. (in)	Flange Dia. (in)	Bore/Bushing	Face Width (in)	Overall Length (in)
80-14MX68-3525	80	D1F	14.036	13.926	14.625	3525	3.328	3.328
90-14MX68-4030	90	D2	15.790	15.680	-	4030	3.328	3.328
112-14MX68-4030	112	D3	19.650	19.540	-	4030	3.328	3.328
140-14MX68-4030	140	D3	24.562	24.452	-	4030	3.328	3.328
168-14MX68-4535	168	C3	29.475	29.365	-	4535	3.328	3.500
180-14MX68-4535	180	C3	31.580	31.470	-	4535	3.328	3.547
200-14MX68-4535	200	C3	35.089	34.979	-	4535	3.328	3.500
224-14MX68-5040	224	C3	39.300	39.190	-	5040	3.328	4.010

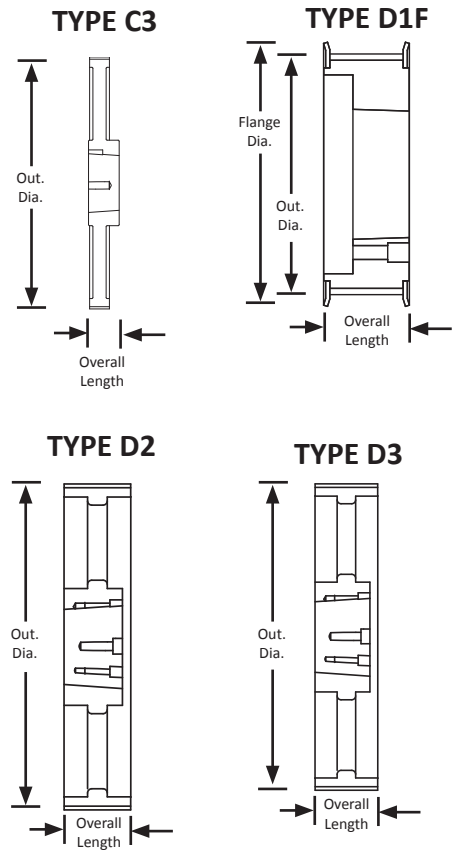

For matching Taper-Lock® bushings, see page 89.

GigaTorque GX TIMING PULLEYS

14 mm Pitch

For 90 mm Wide Belts

Iron

Black Oxide Plating

Minimum Plain Bore/Taper-Lock



Part Number	No. of Teeth	Type	Pitch Dia. (in)	Out. Dia. (in)	Flange Dia. (in)	Bore/Bushing	Face Width (in)	Overall Length (in)
28-14MX90-6FS16	28	6F	4.912	4.802	5.562	1.500	4.203	5.141
29-14MX90-6FS16	29	6F	5.088	4.978	5.562	1.500	4.203	5.000
30-14MX90-6FS16	30	6F	5.263	5.153	5.763	1.500	4.203	5.000
31-14MX90-6FS16	31	6F	5.439	5.329	6.124	1.500	4.203	5.000
32-14MX90-6FS16	32	6F	5.614	5.504	6.124	1.500	4.203	5.000
33-14MX90-6FS16	33	6F	5.790	5.68	6.465	1.500	4.203	5.203
34-14MX90-6FS16	34	6F	5.965	5.855	6.465	1.500	4.203	5.203
35-14MX90-3020	35	A1F	6.141	6.031	6.816	3020	4.203	4.203
35-14MX90-6FS16	35	6F	6.141	6.031	6.816	1.500	4.203	4.203
36-14MX90-3020	36	A1F	6.316	6.206	6.816	3020	4.203	4.203
36-14MX90-6FS16	36	6F	6.316	6.206	6.816	1.500	4.203	4.203
37-14MX90-3020	37	A1F	6.492	6.382	7.167	3020	4.203	4.203
37-14MX90-6FS16	37	6F	6.492	6.382	7.167	1.500	4.203	4.203
38-14MX90-3020	38	A1F	6.667	6.557	7.167	3020	4.203	4.203
38-14MX90-6FS16	38	6F	6.667	6.557	7.167	1.500	4.203	4.203
39-14MX90-3020	39	A1F	6.842	6.732	7.518	3020	4.203	4.203
39-14MX90-6FS16	39	6F	6.842	6.732	7.518	1.500	4.203	4.203
40-14MX90-3020	40	A1F	7.018	6.908	7.518	3020	4.203	4.203
40-14MX90-6FS16	40	6F	7.018	6.908	7.518	1.500	4.203	4.203
43-14MX90-3525	43	A1F	7.544	7.434	8.395	3525	4.203	4.203
45-14MX90-3525	45	A1F	7.895	7.785	8.395	3525	4.203	4.203
48-14MX90-3525	48	A1F	8.421	8.311	8.941	3525	4.203	4.203
50-14MX90-3525	50	A1F	8.772	8.662	9.292	3525	4.203	4.203
53-14MX90-3525	53	A1F	9.299	9.189	9.687	3525	4.203	4.203
56-14MX90-4030	56	A1F	9.825	9.715	10.355	4030	4.203	4.203
60-14MX90-4030	60	A1F	10.527	10.417	11.067	4030	4.203	4.203
63-14MX90-4030	63	A1F	11.053	10.943	11.750	4030	4.203	4.203
67-14MX90-4030	67	A1F	11.755	11.645	12.500	4030	4.203	4.203

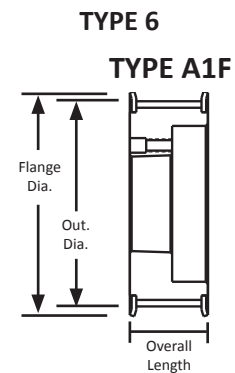
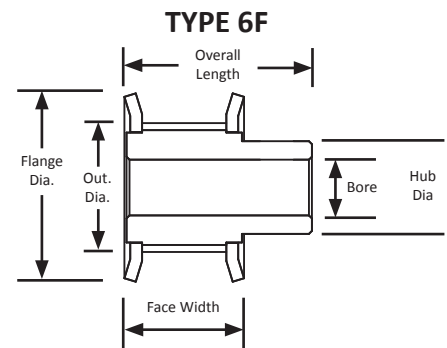

For matching Taper-Lock® bushings, see page 89.

GigaTorque GX TIMING PULLEYS

14 mm Pitch
For 90 mm Wide Belts
Iron
Black Oxide Plating
Taper-Lock® Style



Part Number	No. of Teeth	Type	Pitch Dia. (in)	Out. Dia. (in)	Flange Dia. (in)	Bore/Bushing	Face Width (in)	Overall Length (in)
71-14MX90-4030	71	A1F	12.457	12.347	13.187	4030	4.203	4.203
75-14MX90-4030	75	A1F	13.158	13.048	13.730	4030	4.203	4.203
80-14MX90-4030	80	D1F	14.036	13.926	14.625	4030	4.203	4.203
90-14MX90-4030	90	D2	15.790	15.680	-	4030	4.203	4.203
112-14MX90-4535	112	D2	19.650	19.540	-	4030	4.203	4.203
140-14MX90-5040	140	D3	24.562	24.452	-	4535	4.203	4.203
168-14MX90-6050	168	C3	29.475	29.365	-	5040	4.203	4.203
180-14MX90-6050	180	C3	31.580	31.470	-	6050	4.203	4.203
200-14MX90-6050	200	C3	35.089	34.979	-	6050	4.203	4.203
224-14MX90-6050	224	C3	39.300	39.190	-	6050	4.203	4.203

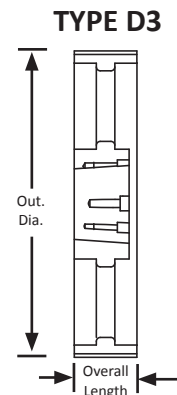
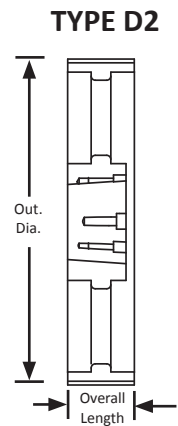
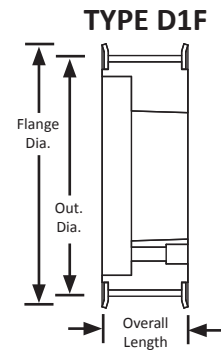
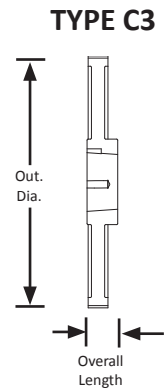
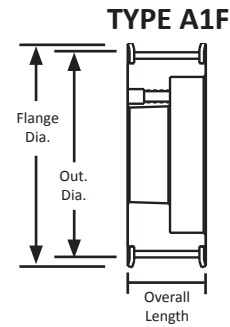

GigaTorque GX TIMING PULLEYS

14 mm Pitch
For 125 mm Wide Belts
Iron
Black Oxide Plating
Minimum Plain Bore/Taper-Lock



Part Number	No. of Teeth	Type	Pitch Dia. (in)	Out. Dia. (in)	Flange Dia. (in)	Bore/Bushing	Face Width (in)	Overall Length (in)
28-14MX125-6FS16	28	6F	4.912	4.802	5.562	1.500	5.609	6.500
29-14MX125-6FS16	29	6F	5.088	4.978	5.562	1.500	5.609	6.500
30-14MX125-6FS16	30	6F	5.263	5.153	5.763	1.500	5.609	6.500
31-14MX125-6FS16	31	6F	5.439	5.329	6.124	1.500	5.609	6.500
32-14MX125-6FS16	32	6F	5.614	5.504	6.124	1.500	5.609	6.500
33-14MX125-6FS16	33	6F	5.790	5.680	6.465	1.500	5.609	6.688
34-14MX125-6FS16	34	6F	5.965	5.855	6.465	1.500	5.609	6.688
35-14MX125-6FS16	35	6F	6.141	6.031	6.816	1.500	5.609	6.688
36-14MX125-6FS16	36	6F	6.316	6.206	6.816	1.500	5.609	6.688
37-14MX125-6FS16	37	6F	6.492	6.382	7.167	1.500	5.609	6.688
38-14MX125-6FS16	38	6F	6.667	6.557	7.167	1.500	5.609	6.688
39-14MX125-6FS16	39	6F	6.842	6.732	7.518	1.500	5.609	6.688
40-14MX125-6FS16	40	6F	7.018	6.908	7.518	1.500	5.609	6.688
43-14MX125-6FS16	43	6F	7.544	7.434	8.395	1.500	5.609	6.813
45-14MX125-6FS16	45	6F	7.895	7.785	8.395	1.500	5.609	6.813
48-14MX125-6FS16	48	6F	8.421	8.311	8.941	1.500	5.609	6.813
50-14MX125-4535	50	A1F	8.772	8.662	9.292	4535	5.609	5.609
53-14MX125-4535	53	A1F	9.299	9.189	9.687	4535	5.609	5.609
56-14MX125-4535	56	A1F	9.825	9.715	10.355	4535	5.609	5.609
60-14MX125-4535	60	A1F	10.527	10.417	11.067	4535	5.609	5.609
63-14MX125-4535	63	A1F	11.053	10.943	11.750	4535	5.609	5.609
67-14MX125-4535	67	A1F	11.755	11.645	12.500	4535	5.609	5.609
71-14MX125-5040	71	A1F	12.457	12.347	13.187	5040	5.609	5.609
75-14MX125-5040	75	A1F	13.158	13.048	13.730	5040	5.609	5.609
80-14MX125-5040	80	A1F	14.036	13.926	14.625	5040	5.609	5.609
90-14MX125-5040	90	D1	15.790	15.680	-	5040	5.609	5.609
112-14MX125-6050	112	A1	19.650	19.540	-	6050	5.609	5.609
140-14MX125-6050	140	D3	24.562	24.452	-	6050	5.609	5.609
168-14MX125-7060	168	C3	29.475	29.365	-	7060	5.609	5.609
180-14MX125-7060	180	C3	31.580	31.470	-	7060	5.609	5.609
200-14MX125-7060	200	C3	35.089	34.979	-	7060	5.609	5.609
224-14MX125-7060	224	C3	39.300	39.190	-	7060	5.609	5.609

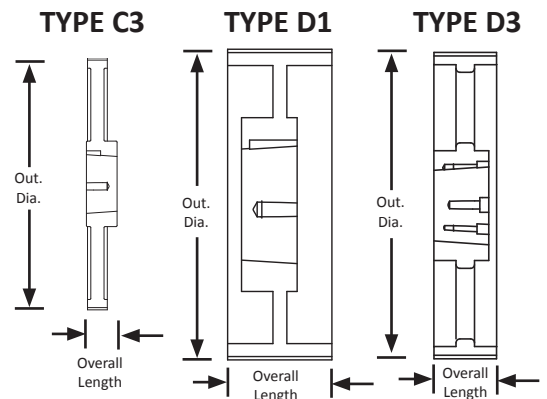
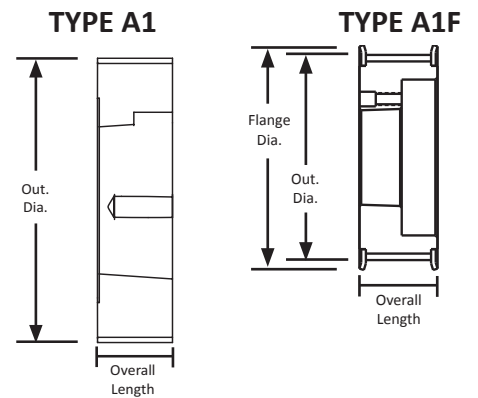
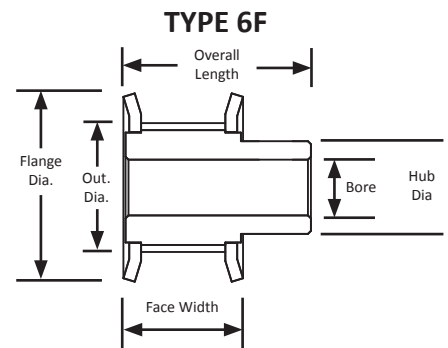

MXL TIMING PULLEYS

0.080" Trapezoidal Pitch

For 1/8" Wide Belts

Hub and Flanges

Aluminum

Clear Anodized

Finished Bore



Part Number	No. of Teeth	Type	Pitch Dia. (in)	Out. Dia. (in)	Flange Dia. (in)	Bore (in)	Face Width (in)	Overall Length (in)	Hub Dia. (in)	Set Screw
10MP012-6CA1	10	6C	0.255	0.235	0.425	0.125	0.201	0.438	0.425	1 x 4-40
11MP012-6CA1	11	6C	0.280	0.260	0.450	0.125	0.201	0.438	0.450	1 x 4-40
12MP012-6CA1	12	6C	0.306	0.286	0.480	0.125	0.201	0.438	0.480	1 x 4-40
14MP012-6CA1	14	6C	0.357	0.337	0.530	0.125	0.201	0.438	0.530	1 x 4-40
15MP012-6CA2	15	6C	0.382	0.362	0.555	0.188	0.201	0.438	0.555	1 x 4-40
16MP012-6CA2	16	6C	0.407	0.387	0.580	0.188	0.201	0.438	0.580	1 x 4-40
18MP012-6FA2	18	6F	0.458	0.438	0.635	0.188	0.260	0.484	0.312	2 x 4-40 @ 90°
18MP012-6CA3	18	6C	0.458	0.438	0.635	0.250	0.208	0.438	0.635	2 x 4-40 @ 90°
20MP012-6FA2	20	6F	0.509	0.489	0.685	0.188	0.260	0.484	0.364	2 x 4-40 @ 90°
20MP012-6CA3	20	6C	0.509	0.489	0.685	0.250	0.208	0.438	0.685	2 x 4-40 @ 90°
21MP012-6FA2	21	6F	0.535	0.515	0.710	0.188	0.260	0.484	0.390	2 x 4-40 @ 90°
21MP012-6CA3	21	6C	0.535	0.515	0.710	0.250	0.208	0.438	0.710	2 x 4-40 @ 90°
22MP012-6FA2	22	6F	0.560	0.540	0.740	0.188	0.260	0.484	0.390	2 x 4-40 @ 90°
22MP012-6CA3	22	6C	0.560	0.540	0.740	0.250	0.208	0.438	0.740	2 x 4-40 @ 90°
24MP012-6FA3	24	6F	0.611	0.591	0.790	0.250	0.260	0.516	0.442	2 x 6-40 @ 90°
28MP012-6FA3	28	6F	0.713	0.693	0.895	0.250	0.260	0.484	0.494	2 x 6-40 @ 90°
30MP012-6FA3	30	6F	0.764	0.744	0.945	0.250	0.260	0.516	0.546	2 x 6-40 @ 90°
32MP012-6FA3	32	6F	0.815	0.795	1.000	0.250	0.260	0.516	0.598	2 x 6-40 @ 90°
36MP012-6FA3	36	6F	0.917	0.897	1.105	0.250	0.260	0.516	0.676	2 x 6-40 @ 90°
40MP012-6FA3	40	6F	1.019	0.999	1.210	0.250	0.276	0.531	0.754	2 x 6-40 @ 90°
42MP012-6FA3	42	6F	1.070	1.050	1.260	0.250	0.276	0.531	0.806	2 x 6-40 @ 90°
44MP012-6FA3	44	6F	1.120	1.100	1.315	0.250	0.276	0.531	0.858	2 x 6-40 @ 90°
48MP012-6FA3	48	6F	1.222	1.202	1.420	0.250	0.276	0.531	0.936	2 x 6-40 @ 90°
60MP012-6FA3	60	6F	1.528	1.508	1.730	0.250	0.276	0.531	1.222	2 x 6-40 @ 90°

TYPE 6C

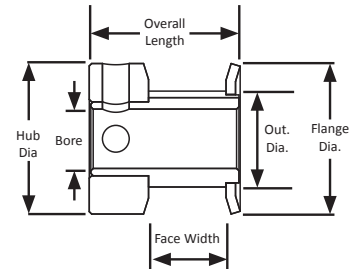

TYPE 6F

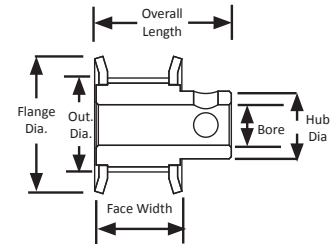

For matching MXL pitch belts, see page 19 in the MBL Industrial Catalog.

MXL is an imperial pitch which is based on the "inch" system of measurement. The imperial pitch tooth profile is a commonly found profile and is trapezoidal in shape. Imperial pitch pulley part numbers can tell you a great deal about the pulley including the number of teeth, pitch, belt width, unit of measure, appearance, material, and bore size.

MXL TIMING PULLEYS

0.080" Trapezoidal Pitch

For 1/4" Wide Belts

Hub

Aluminum

Clear Anodized

Finished Bore

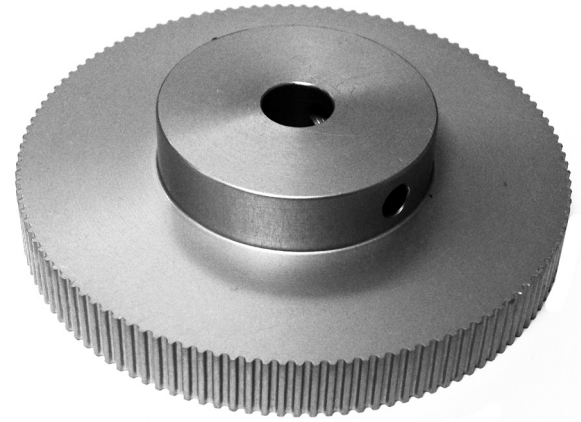

Part Number	No. of Teeth	Type	Pitch Dia. (in)	Out. Dia. (in)	Flange Dia. (in)	Bore (in)	Face Width (in)	Overall Length (in)	Hub Dia. (in)	Set Screw
10MP025-6CA1	10	6C	0.255	0.235	0.425	0.125	0.330	0.563	0.425	1 x 4-40
11MP025-6CA1	11	6C	0.280	0.260	0.450	0.125	0.330	0.563	0.450	1 x 4-40
12MP025-6CA1	12	6C	0.306	0.286	0.480	0.125	0.330	0.563	0.480	1 x 4-40
14MP025-6CA1	14	6C	0.357	0.337	0.530	0.125	0.330	0.563	0.530	1 x 4-40
15MP025-6CA2	15	6C	0.382	0.362	0.555	0.188	0.330	0.563	0.555	1 x 6-40
16MP025-6CA2	16	6C	0.407	0.387	0.580	0.188	0.330	0.563	0.580	1 x 6-40
18MP025-6FA2	18	6F	0.458	0.438	0.635	0.188	0.389	0.625	0.312	2 x 6-40 @ 90°
18MP025-6CA3	18	6C	0.458	0.438	0.635	0.250	0.337	0.563	0.635	2 x 6-40 @ 90°
20MP025-6FA2	20	6F	0.509	0.489	0.685	0.188	0.389	0.625	0.364	2 x 6-40 @ 90°
20MP025-6CA3	20	6C	0.509	0.489	0.685	0.250	0.337	0.563	0.685	2 x 6-40 @ 90°
21MP025-6FA2	21	6F	0.535	0.515	0.710	0.188	0.389	0.625	0.390	2 x 6-40 @ 90°
21MP025-6CA3	21	6C	0.535	0.515	0.710	0.250	0.337	0.563	0.710	2 x 6-40 @ 90°
22MP025-6FA2	22	6F	0.560	0.540	0.740	0.188	0.389	0.625	0.390	2 x 6-40 @ 90°
22MP025-6CA3	22	6C	0.560	0.540	0.740	0.250	0.337	0.688	0.740	2 x 6-40 @ 90°
24MP025-6FA3	24	6F	0.611	0.591	0.790	0.250	0.389	0.688	0.442	2 x 6-40 @ 90°
25MP025-6FA3	25	6F	0.637	0.617	0.815	0.250	0.389	0.688	0.468	2 x 6-40 @ 90°
28MP025-6FA3	28	6F	0.713	0.693	0.895	0.250	0.389	0.688	0.494	2 x 6-40 @ 90°
28MP025-6FA4	28	6F	0.713	0.693	0.895	0.313	0.389	0.688	0.494	2 x 6-40 @ 90°
30MP025-6FA3	30	6F	0.764	0.744	0.945	0.250	0.389	0.688	0.546	2 x 8-32 @ 90°
30MP025-6FA4	30	6F	0.764	0.744	0.945	0.313	0.389	0.688	0.546	2 x 8-32 @ 90°
32MP025-6FA3	32	6F	0.815	0.795	1.000	0.250	0.389	0.688	0.598	2 x 8-32 @ 90°
36MP025-6FA3	36	6F	0.917	0.897	1.105	0.250	0.389	0.688	0.676	2 x 8-32 @ 90°
40MP025-6FA3	40	6F	1.019	0.999	1.210	0.250	0.405	0.719	0.754	2 x 8-32 @ 90°
42MP025-6FA3	42	6F	1.070	1.050	1.260	0.250	0.405	0.719	0.806	2 x 8-32 @ 90°
44MP025-6FA3	44	6F	1.120	1.100	1.315	0.250	0.405	0.719	0.858	2 x 8-32 @ 90°
48MP025-6FA3	48	6F	1.222	1.202	1.420	0.250	0.405	0.719	0.936	2 x 8-32 @ 90°
50MP025-6FA3	50	6F	1.273	1.253	1.470	0.250	0.405	0.719	0.966	2 x 8-32 @ 90°
60MP025-6FA3	60	6F	1.528	1.508	1.730	0.250	0.405	0.719	1.222	2 x 8-32 @ 90°
60MP025-6A3	60	6	1.528	1.508	-	0.250	0.375	0.750	1.148	2 x 8-32 @ 90°
72MP025-6A3	72	6	1.833	1.813	-	0.250	0.375	0.750	1.195	2 x 8-32 @ 90°
72MP025-6A3	72	6	1.833	1.813	-	0.313	0.375	0.750	1.195	2 x 8-32 @ 90°
80MP025-6A4	80	6	2.037	2.017	-	0.313	0.375	0.750	1.500	2 x 8-32 @ 90°
90MP025-6A4	90	6	2.292	2.272	-	0.313	0.375	0.750	1.500	2 x 8-32 @ 90°
100MP025-6A4	100	6	2.546	2.526	-	0.313	0.375	0.750	1.500	2 x 8-32 @ 90°
120MP025-6A5	120	6	3.056	3.036	-	0.375	0.375	0.750	1.500	2 x 10-32 @ 90°

TYPE 6C

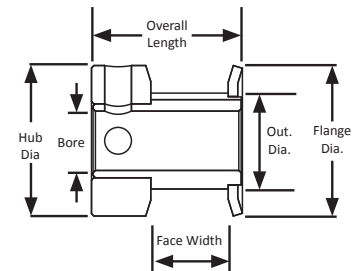

TYPE 6F

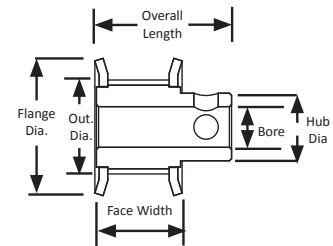

TYPE 6

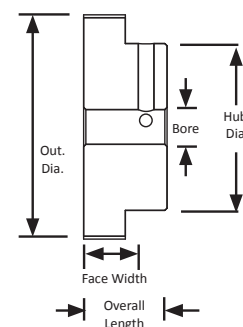

MXL TIMING PULLEYS

0.080" Trapezoidal Pitch

For 3/8" Wide Belts

Hub

Aluminum

Clear Anodized

Finished Bore



Part Number	No. of Teeth	Type	Pitch Dia. (in)	Out. Dia. (in)	Flange Dia. (in)	Bore (in)	Face Width (in)	Overall Length (in)	Hub Dia. (in)	Set Screw
10MP037-6CA1	10	6C	0.255	0.235	0.425	0.125	0.455	0.688	0.425	1 x 4-40
11MP037-6CA1	11	6C	0.280	0.260	0.450	0.125	0.455	0.688	0.450	1 x 4-40
12MP037-6CA1	12	6C	0.306	0.286	0.480	0.125	0.455	0.688	0.480	1 x 4-40
14MP037-6CA1	14	6C	0.357	0.337	0.530	0.125	0.455	0.688	0.530	1 x 4-40
15MP037-6CA2	15	6C	0.382	0.362	0.555	0.188	0.455	0.688	0.555	1 x 6-40
16MP037-6CA2	16	6C	0.407	0.387	0.580	0.188	0.455	0.688	0.580	1 x 6-40
18MP037-6FA2	18	6F	0.458	0.438	0.635	0.188	0.514	0.750	0.312	2 x 6-40 @ 90°
18MP037-6CA3	18	6C	0.458	0.438	0.635	0.250	0.462	0.688	0.635	2 x 6-40 @ 90°
20MP037-6FA2	20	6F	0.509	0.489	0.685	0.188	0.514	0.750	0.364	2 x 6-40 @ 90°
20MP037-6CA3	20	6C	0.509	0.489	0.685	0.250	0.462	0.688	0.685	2 x 6-40 @ 90°
21MP037-6FA2	21	6F	0.535	0.515	0.710	0.188	0.514	0.750	0.390	2 x 6-40 @ 90°
21MP037-6CA3	21	6C	0.535	0.515	0.710	0.250	0.462	0.688	0.710	2 x 6-40 @ 90°
22MP037-6FA2	22	6F	0.560	0.540	0.740	0.188	0.514	0.750	0.390	2 x 6-40 @ 90°
22MP037-6CA3	22	6C	0.560	0.540	0.740	0.250	0.462	0.688	0.740	2 x 6-40 @ 90°
24MP037-6FA3	24	6F	0.611	0.591	0.790	0.250	0.514	0.813	0.442	2 x 6-40 @ 90°
25MP037-6FA3	25	6F	0.637	0.617	0.815	0.250	0.514	0.813	0.468	2 x 6-40 @ 90°
28MP037-6FA3	28	6F	0.713	0.693	0.895	0.250	0.514	0.813	0.494	2 x 6-40 @ 90°
30MP037-6FA3	30	6F	0.764	0.744	0.945	0.250	0.514	0.813	0.546	2 x 8-32 @ 90°
32MP037-6FA3	32	6F	0.815	0.795	1.000	0.250	0.514	0.813	0.598	2 x 8-32 @ 90°
36MP037-6FA3	36	6F	0.917	0.897	1.105	0.250	0.514	0.813	0.676	2 x 8-32 @ 90°
40MP037-6FA3	40	6F	1.019	0.999	1.210	0.250	0.530	0.844	0.754	2 x 8-32 @ 90°
42MP037-6FA3	42	6F	1.070	1.050	1.260	0.250	0.530	0.844	0.806	2 x 8-32 @ 90°
44MP037-6FA3	44	6F	1.120	1.100	1.315	0.250	0.530	0.844	0.858	2 x 8-32 @ 90°
48MP037-6FA3	48	6F	1.222	1.202	1.420	0.250	0.530	0.844	0.936	2 x 8-32 @ 90°
60MP037-6FA3	60	6F	1.528	1.508	1.730	0.250	0.530	0.844	1.222	2 x 8-32 @ 90°
60MP037-6A3	60	6	1.528	1.508	-	0.250	0.500	0.875	1.148	2 x 8-32 @ 90°
72MP037-6A3	72	6	1.833	1.813	-	0.250	0.500	0.875	1.195	2 x 8-32 @ 90°
80MP037-6A4	80	6	2.037	2.017	-	0.313	0.500	0.875	1.500	2 x 8-32 @ 90°
90MP037-6A4	90	6	2.292	2.272	-	0.313	0.500	0.875	1.500	2 x 8-32 @ 90°
100MP037-6A4	100	6	2.546	2.526	-	0.313	0.500	0.875	1.500	2 x 8-32 @ 90°
120MP037-6A5	120	6	3.056	3.036	-	0.375	0.500	0.875	1.500	2 x 10-32 @ 90°

TYPE 6C

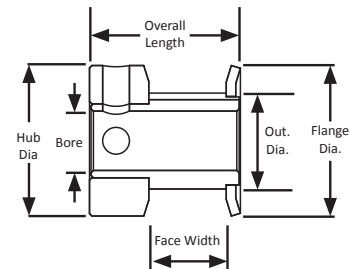

TYPE 6F

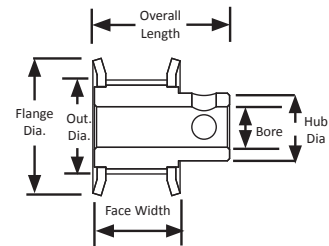

TYPE 6

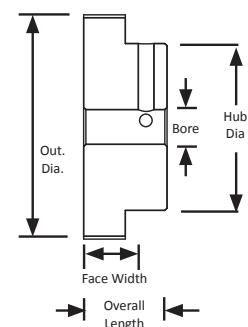

MXL TIMING PULLEYS

METRIC TIMING PULLEY

2.03mm Trapezoidal Pitch

For 3mm Wide Belts

Hub and Flanges

Aluminum

Clear Anodized

Metric Finished Bore



Part Number	No. of Teeth	Type	Pitch Dia. (mm)	Out. Dia. (mm)	Flange Dia. (mm)	Bore (mm)	Face Width (mm)	Overall Length (mm)	Hub Dia. (mm)	Set Screw
10MP012M6CA3	10	6C	6.5	6.0	10.8	3.0	-	11.1	10.8	M2
11MP012M6CA3	11	6C	7.1	6.6	11.4	3.0	-	11.1	11.4	M2
12MP012M6CA3	12	6C	7.8	7.3	12.2	3.0	-	11.1	12.2	M2
14MP012M6CA3	14	6C	9.1	8.6	13.5	3.0	-	11.1	13.5	M2
15MP012M6CA5	15	6C	9.7	9.2	14.1	5.0	-	11.1	14.1	M3
16MP012M6CA5	16	6C	10.3	9.8	14.7	5.0	-	11.1	14.7	M2
18MP012M6FA5	18	6F	11.6	11.1	16.1	5.0	-	12.3	7.9	2 x M2 @ 90°
20MP012M6FA5	20	6F	12.9	12.4	17.4	5.0	6.6	12.3	9.2	2 x M2 @ 90°
21MP012M6FA5	21	6F	13.6	13.1	18.0	5.0	6.6	12.3	9.9	2 x M2 @ 90°
22MP012M6FA5	22	6F	14.2	13.7	18.8	5.0	6.6	12.3	9.9	2 x M2 @ 90°
24MP012M6FA6	24	6F	15.5	15.0	20.1	6.0	6.6	13.1	11.2	2 x M3 @ 90°
28MP012M6FA6	28	6F	18.1	17.6	22.7	6.0	6.6	13.1	12.5	2 x M3 @ 90°
30MP012M6FA6	30	6F	19.4	18.9	24.0	6.0	6.6	13.1	13.9	2 x M3 @ 90°
32MP012M6FA6	32	6F	20.7	20.2	25.4	6.0	6.6	13.1	15.2	2 x M3 @ 90°
36MP012M6FA6	36	6F	23.3	22.8	28.1	6.0	6.6	13.1	17.2	2 x M3 @ 90°
40MP012M6FA6	40	6F	25.9	25.4	30.7	6.0	7.0	13.5	19.2	2 x M3 @ 90°
42MP012M6FA6	42	6F	27.2	26.7	32.0	6.0	7.0	13.5	20.5	2 x M3 @ 90°
44MP012M6FA6	44	6F	28.5	28.0	33.4	6.0	7.0	13.5	21.8	2 x M3 @ 90°
48MP012M6FA6	48	6F	31.0	30.5	36.1	6.0	7.0	13.5	23.8	2 x M3 @ 90°
60MP012M6FA6	60	6F	38.8	38.3	43.9	6.0	7.0	13.5	31.0	2 x M3 @ 90°

TYPE 6C

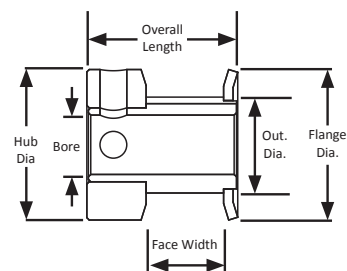

TYPE 6F

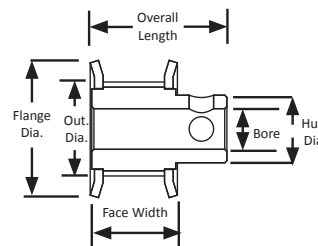

MXL TIMING PULLEYS

METRIC TIMING PULLEY

2.03mm Trapezoidal Pitch

For 6mm Wide Belts

Hub and Flanges

Aluminum

Clear Anodized

Metric Finished Bore



Part Number	No. of Teeth	Type	Pitch Dia. (mm)	Out. Dia. (mm)	Flange Dia. (mm)	Bore (mm)	Face Width (mm)	Overall Length (mm)	Hub Dia. (mm)	Set Screw
10MP025M6CA3	10	6C	6.5	6.0	10.8	3.0	-	14.3	10.8	M2
11MP025M6CA3	11	6C	7.1	6.6	11.4	3.0	-	14.3	11.4	M2
12MP025M6CA3	12	6C	7.8	7.3	12.2	3.0	-	14.3	12.2	M2
14MP025M6CA3	14	6C	9.1	8.6	13.5	3.0	-	14.3	13.5	M2
15MP025M6CA4	15	6C	9.7	9.2	14.1	4.0	-	14.3	14.1	M2.5
16MP025M6CA4	16	6C	10.3	9.8	14.7	4.0	-	14.3	14.7	M2.5
16MP025M6CA5	16	6C	10.3	9.8	14.7	5.0	-	14.3	14.7	M2.5
18MP025M6FA4	18	6F	11.6	11.1	16.1	4.0	9.9	15.9	7.9	2 x M2.5 @ 90°
18MP025M6FA5	18	6F	11.6	11.1	16.1	5.0	9.9	15.9	7.9	2 x M2.5 @ 90°
18MP025M6CA6	18	6C	11.6	11.1	16.1	6.0	-	14.3	16.1	2 x M3 @ 90°
20MP025M6FA4	20	6F	12.9	12.4	17.4	4.0	9.9	15.9	9.2	2 x M2.5 @ 90°
20MP025M6CA5	20	6C	12.9	12.4	17.4	5.0	-	14.3	17.4	2 x M3 @ 90°
20MP025M6CA6	20	6C	12.9	12.4	17.4	6.0	-	14.3	17.4	2 x M3 @ 90°
21MP025M6FA4	21	6F	13.6	13.1	18.0	4.0	9.9	15.9	9.9	2 x M2.5 @ 90°
21MP025M6CA6	21	6C	13.6	13.1	18.0	6.0	-	14.3	18.0	2 x M3 @ 90°
22MP025M6FA4	22	6F	14.2	13.7	18.8	4.0	9.9	15.9	9.9	2 x M2.5 @ 90°
22MP025M6FA5	22	6F	14.2	13.7	18.8	5.0	9.9	15.9	9.9	2 x M2.5 @ 90°
22MP025M6CA6	22	6C	14.2	13.7	18.8	6.0	-	14.3	18.8	2 x M3 @ 90°
24MP025M6FA5	24	6F	15.5	15.0	20.1	5.0	9.9	17.5	11.2	2 x M3 @ 90°
24MP025M6FA6	24	6F	15.5	15.0	20.1	6.0	9.9	17.5	11.2	2 x M3 @ 90°
25MP025M6FA6	25	6F	16.2	15.7	20.7	6.0	9.9	17.5	11.9	2 x M3 @ 90°
28MP025M6FA6	28	6F	18.1	17.6	22.7	6.0	9.9	17.5	12.5	2 x M3 @ 90°

TYPE 6C

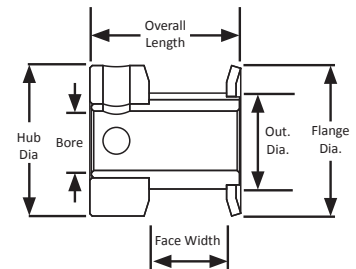

TYPE 6F

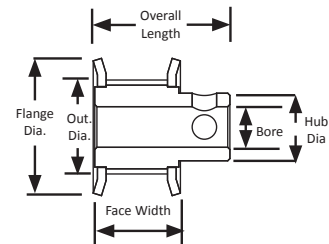

For matching MXL pitch belts,
see page 19 in the MBL Industrial Catalog.

MXL TIMING PULLEYS

METRIC TIMING PULLEY

2.03mm Trapezoidal Pitch

For 6mm Wide Belts

Hub

Aluminum

Clear Anodized

Metric Finished Bore



Part Number	No. of Teeth	Type	Pitch Dia. (mm)	Out. Dia. (mm)	Flange Dia. (mm)	Bore (mm)	Face Width (mm)	Overall Length (mm)	Hub Dia. (mm)	Set Screw
30MP025M6FA6	30	6F	19.4	18.9	24.0	6.0	9.9	17.5	13.9	2 x M3 @ 90°
30MP025M6FA8	30	6F	19.4	18.9	24.0	8.0	9.9	17.5	13.9	2 x M3 @ 90°
32MP025M6FA6	32	6F	20.7	20.2	25.4	6.0	9.9	17.5	15.2	2 x M3 @ 90°
36MP025M6FA6	36	6F	23.3	22.8	28.1	6.0	9.9	17.5	17.2	2 x M3 @ 90°
40MP025M6FA6	40	6F	25.9	25.4	30.7	6.0	10.3	18.3	19.2	2 x M3 @ 90°
42MP025M6FA6	42	6F	27.2	26.7	32.0	6.0	10.3	18.3	20.5	2 x M3 @ 90°
44MP025M6FA6	44	6F	28.5	28.0	33.4	6.0	10.3	18.3	21.8	2 x M3 @ 90°
48MP025M6FA6	48	6F	31.0	30.5	36.1	6.0	10.3	18.3	23.8	2 x M3 @ 90°
60MP025M6FA6	60	6F	38.8	38.3	43.9	6.0	10.3	18.3	31.0	2 x M3 @ 90°
60MP025M6A6	60	6	38.8	38.3	-	6.0	-	19.1	29.2	2 x M3 @ 90°
72MP025M6A6	72	6	46.6	46.1	-	6.0	-	19.1	30.4	2 x M3 @ 90°
80MP025M6A8	80	6	51.7	51.2	-	8.0	-	19.1	38.1	2 x M4 @ 90°
90MP025M6A8	90	6	58.2	57.7	-	8.0	-	19.1	38.1	2 x M4 @ 90°
100MP025M6A8	100	6	64.7	64.2	-	8.0	-	19.1	38.1	2 x M4 @ 90°
120MP025M6A10	120	6	77.6	77.1	-	10.0	-	19.1	38.1	2 x M5 @ 90°

TYPE 6F

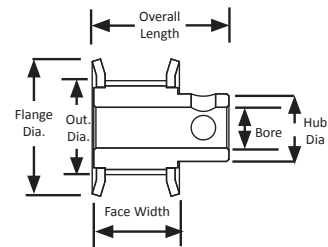

TYPE 6

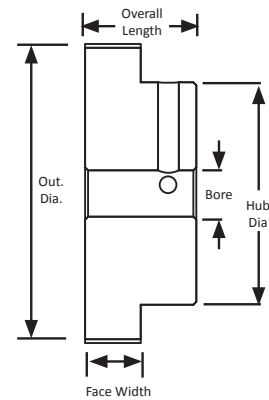

MXL TIMING PULLEYS

METRIC TIMING PULLEY

2.03mm Trapezoidal Pitch

For 9.5mm Wide Belts

Hub

Aluminum

Clear Anodized

Metric Finished Bore

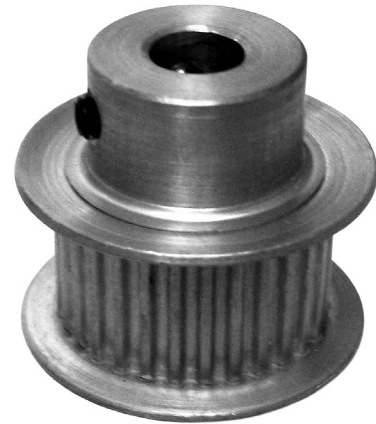

Part Number	No. of Teeth	Type	Pitch Dia. (mm)	Out. Dia. (mm)	Flange Dia. (mm)	Bore (mm)	Face Width (mm)	Overall Length (mm)	Hub Dia. (mm)	Set Screw
10MP037M6CA3	10	6C	6.5	6.0	10.8	3.0	-	17.5	10.8	M2
11MP037M6CA3	11	6C	7.1	6.6	11.4	3.0	-	17.5	11.4	M2
12MP037M6CA3	12	6C	7.8	7.3	12.2	3.0	-	17.5	12.2	M2
14MP037M6CA3	14	6C	9.1	8.6	13.5	3.0	-	17.5	13.5	M2
15MP037M6CA4	15	6C	9.7	9.2	14.1	4.0	-	17.5	14.1	M2.5
16MP037M6CA4	16	6C	10.3	9.8	14.7	4.0	-	17.5	14.7	M2.5
18MP037M6FA4	18	6F	11.6	11.1	16.1	4.0	13.1	19.1	7.9	2 x M2.5 @ 90°
18MP037M6CA6	18	6C	11.6	11.1	16.1	6.0	-	17.5	16.1	2 x M3 @ 90°
20MP037M6FA4	20	6F	12.9	12.4	17.4	4.0	13.1	19.1	9.2	2 x M2.5 @ 90°
20MP037M6CA6	20	6C	12.9	12.4	17.4	6.0	-	17.5	17.4	2 x M3 @ 90°
21MP037M6FA4	21	6F	13.6	13.1	18.0	4.0	13.1	19.1	9.9	2 x M2.5 @ 90°
21MP037M6CA6	21	6C	13.6	13.1	18.0	6.0	-	17.5	18.0	2 x M3 @ 90°
22MP037M6FA4	22	6F	14.2	13.7	18.8	4.0	13.1	19.1	9.9	2 x M2.5 @ 90°
22MP037M6CA6	22	6C	14.2	13.7	18.8	6.0	-	17.5	18.8	2 x M3 @ 90°
24MP037M6FA6	24	6F	15.5	15.0	20.1	6.0	13.1	20.6	11.2	2 x M3 @ 90°
25MP037M6FA6	25	6F	16.2	15.7	20.7	6.0	13.1	20.6	11.9	2 x M3 @ 90°
28MP037M6FA6	28	6F	18.1	17.6	22.7	6.0	13.1	20.6	12.5	2 x M3 @ 90°
30MP037M6FA6	30	6F	19.4	18.9	24.0	6.0	13.1	20.6	13.9	2 x M3 @ 90°
32MP037M6FA6	32	6F	20.7	20.2	25.4	6.0	13.1	20.6	15.2	2 x M3 @ 90°
36MP037M6FA6	36	6F	23.3	22.8	28.1	6.0	13.1	20.6	17.2	2 x M3 @ 90°
40MP037M6FA6	40	6F	25.9	25.4	30.7	6.0	13.5	21.4	19.2	2 x M3 @ 90°
42MP037M6FA6	42	6F	27.2	26.7	32.0	6.0	13.5	21.4	20.5	2 x M3 @ 90°
44MP037M6FA6	44	6F	28.5	28.0	33.4	6.0	13.5	21.4	21.8	2 x M3 @ 90°
48MP037M6FA6	48	6F	31.0	30.5	36.1	6.0	13.5	21.4	23.8	2 x M3 @ 90°
60MP037M6FA6	60	6F	38.8	38.3	43.9	6.0	13.5	21.4	31.0	2 x M3 @ 90°
60MP037M6A6	60	6	38.8	38.3	-	6.0	-	22.2	29.2	2 x M3 @ 90°
72MP037M6A6	72	6	46.6	46.1	-	6.0	-	22.2	30.4	2 x M3 @ 90°
80MP037M6A8	80	6	51.7	51.2	-	8.0	-	22.2	38.1	2 x M4 @ 90°
90MP037M6A8	90	6	58.2	57.7	-	8.0	-	22.2	38.1	2 x M4 @ 90°
100MP037M6A8	100	6	64.7	64.2	-	8.0	-	22.2	38.1	2 x M4 @ 90°
120MP037M6A10	120	6	77.6	77.1	-	10.0	-	22.2	38.1	2 x M5 @ 90°

TYPE 6C

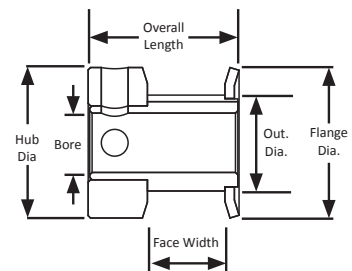

TYPE 6F

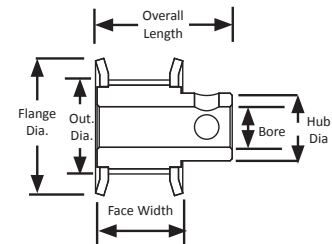

TYPE 6

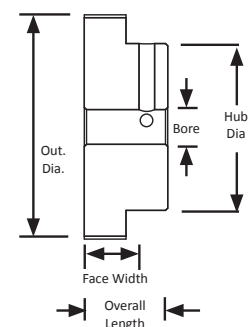

XL TIMING PULLEYS

0.200" Trapezoidal Pitch

For 1/4" Wide Belts

Hub and Flanges

Aluminum

Clear Anodized

Finished Bore



Part Number	No. of Teeth	Type	Pitch Dia (in)	Out. Dia (in)	Flange Dia. (in)	Bore (in)	Face Width (in)	Overall Length (in)	Hub Dia. (in)	Set Screw
10XL025-6FA2	10	6F	0.637	0.617	0.875	0.188	0.438	0.688	0.375	1 x 6-40
10XL025-6FA3	10	6F	0.637	0.617	0.875	0.250	0.438	0.688	0.375	1 x 6-40
11XL025-6FA2	11	6F	0.700	0.680	0.938	0.188	0.438	0.688	0.438	2 x 6-40 @ 90°
11XL025-6FA3	11	6F	0.700	0.680	0.938	0.250	0.438	0.688	0.438	2 x 6-40 @ 90°
12XL025-6FA2	12	6F	0.764	0.744	1.000	0.188	0.438	0.688	0.500	2 x 6-40 @ 90°
12XL025-6FA3	12	6F	0.764	0.744	1.000	0.250	0.438	0.688	0.500	2 x 8-32 @ 90°
12XL025-6FA4	12	6F	0.764	0.744	1.000	0.313	0.438	0.688	0.500	2 x 8-32 @ 90°
13XL025-6FA3	13	6F	0.828	0.808	1.063	0.250	0.438	0.688	0.563	2 x 8-32 @ 90°
13XL025-6FA4	13	6F	0.828	0.808	1.063	0.313	0.438	0.688	0.563	2 x 8-32 @ 90°
14XL025-6FA3	14	6F	0.891	0.871	1.094	0.250	0.438	0.688	0.563	2 x 8-32 @ 90°
14XL025-6FA4	14	6F	0.891	0.871	1.094	0.313	0.438	0.688	0.563	2 x 8-32 @ 90°
14XL025-6FA5	14	6F	0.891	0.871	1.094	0.375	0.438	0.688	0.563	2 x 8-32 @ 90°
15XL025-6FA3	15	6F	0.955	0.935	1.188	0.250	0.438	0.688	0.625	2 x 8-32 @ 90°
15XL025-6FA4	15	6F	0.955	0.935	1.188	0.313	0.438	0.688	0.625	2 x 8-32 @ 90°
15XL025-6FA5	15	6F	0.955	0.935	1.188	0.375	0.438	0.688	0.750	2 x 10-32 @ 90°
15XL025-6FA6	15	6F	0.955	0.935	1.188	0.500	0.438	0.688	0.750	2 x 10-32 @ 90°
16XL025-6FA3	16	6F	1.019	0.999	1.250	0.250	0.438	0.688	0.688	2 x 8-32 @ 90°
16XL025-6FA4	16	6F	1.019	0.999	1.250	0.313	0.438	0.688	0.688	2 x 8-32 @ 90°
16XL025-6FA5	16	6F	1.019	0.999	1.250	0.375	0.438	0.688	0.688	2 x 10-32 @ 90°
16XL025-6FA6	16	6F	1.019	0.999	1.250	0.500	0.438	0.688	0.688	2 x 10-32 @ 90°
18XL025-6FA3	18	6F	1.146	1.126	1.375	0.250	0.438	0.688	0.812	2 x 8-32 @ 90°
18XL025-6FA4	18	6F	1.146	1.126	1.375	0.313	0.438	0.688	0.812	2 x 8-32 @ 90°
18XL025-6FA5	18	6F	1.146	1.126	1.375	0.375	0.438	0.688	0.812	2 x 10-32 @ 90°
18XL025-6FA6	18	6F	1.146	1.126	1.375	0.500	0.438	0.688	0.812	2 x 10-32 @ 90°
20XL025-6FA3	20	6F	1.273	1.253	1.500	0.250	0.438	0.750	0.938	2 x 8-32 @ 90°

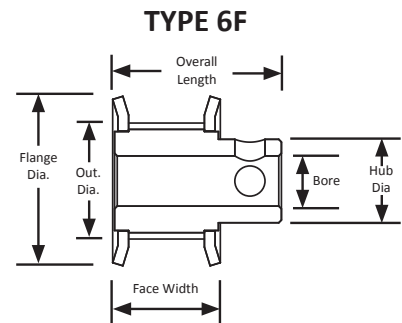

XL TIMING PULLEYS

0.200" Trapezoidal Pitch

For 1/4" Wide Belts

Hub and Flanges

Aluminum

Clear Anodized

Finished Bore



Part Number	No. of Teeth	Type	Pitch Dia. (in)	Out. Dia. (in)	Flange Dia. (in)	Bore (in)	Face Width (in)	Overall Length (in)	Hub Dia. (in)	Set Screw
20XL025-6FA4	20	6F	1.273	1.253	1.500	0.313	0.438	0.750	0.938	2 x 8-32 @ 90°
20XL025-6FA5	20	6F	1.273	1.253	1.500	0.375	0.438	0.750	0.938	2 x 10-32 @ 90°
20XL025-6FA6	20	6F	1.273	1.253	1.500	0.500	0.438	0.750	0.938	2 x 10-32 @ 90°
21XL025-6FA3	21	6F	1.337	1.317	1.563	0.250	0.438	0.750	1.000	2 x 8-32 @ 90°
21XL025-6FA4	21	6F	1.337	1.317	1.563	0.313	0.438	0.750	1.000	2 x 8-32 @ 90°
21XL025-6FA5	21	6F	1.337	1.317	1.563	0.375	0.438	0.750	1.000	2 x 10-32 @ 90°
21XL025-6FA6	21	6F	1.337	1.317	1.563	0.500	0.438	0.750	1.000	2 x 10-32 @ 90°
22XL025-6FA3	22	6F	1.401	1.381	1.625	0.250	0.438	0.750	1.000	2 x 8-32 @ 90°
22XL025-6FA4	22	6F	1.401	1.381	1.625	0.313	0.438	0.750	1.000	2 x 8-32 @ 90°
22XL025-6FA5	22	6F	1.401	1.381	1.625	0.375	0.438	0.750	1.000	2 x 10-32 @ 90°
22XL025-6FA6	22	6F	1.401	1.381	1.625	0.500	0.438	0.750	1.000	2 x 10-32 @ 90°
24XL025-6FA3	24	6F	1.528	1.508	1.750	0.250	0.438	0.781	1.062	2 x 8-32 @ 90°
24XL025-6FA4	24	6F	1.528	1.508	1.750	0.313	0.438	0.781	1.062	2 x 8-32 @ 90°
24XL025-6FA5	24	6F	1.528	1.508	1.750	0.375	0.438	0.781	1.062	2 x 10-32 @ 90°
24XL025-6FA6	24	6F	1.528	1.508	1.750	0.500	0.438	0.781	1.062	2 x 10-32 @ 90°
26XL025-6FA3	26	6F	1.655	1.635	1.875	0.250	0.438	0.781	1.188	2 x 8-32 @ 90°
26XL025-6FA4	26	6F	1.665	1.635	1.875	0.313	0.438	0.781	1.188	2 x 8-32 @ 90°
26XL025-6FA5	26	6F	1.665	1.635	1.875	0.375	0.438	0.781	1.188	2 x 10-32 @ 90°
26XL025-6FA6	26	6F	1.665	1.635	1.875	0.500	0.438	0.781	1.188	2 x 10-32 @ 90°
28XL025-6FA3	28	6F	1.783	1.763	2.000	0.250	0.438	0.781	1.188	2 x 8-32 @ 90°
28XL025-6FA4	28	6F	1.783	1.763	2.000	0.313	0.438	0.781	1.188	2 x 8-32 @ 90°
28XL025-6FA5	28	6F	1.783	1.763	2.000	0.375	0.438	0.781	1.188	2 x 10-32 @ 90°
28XL025-6FA6	28	6F	1.783	1.763	2.000	0.500	0.438	0.781	1.188	2 x 10-32 @ 90°
28XL025-6FA7	28	6F	1.783	1.763	2.000	0.625	0.438	0.781	1.188	2 x 10-32 @ 90°
30XL025-6FA3	30	6F	1.910	1.890	2.125	0.250	0.438	0.781	1.313	2 x 8-32 @ 90°
30XL025-6FA4	30	6F	1.910	1.890	2.125	0.313	0.438	0.781	1.313	2 x 8-32 @ 90°
30XL025-6FA5	30	6F	1.910	1.890	2.125	0.375	0.438	0.781	1.313	2 x 10-32 @ 90°
30XL025-6FA6	30	6F	1.910	1.890	2.125	0.500	0.438	0.781	1.313	2 x 10-32 @ 90°
30XL025-6FA7	30	6F	1.910	1.890	2.125	0.625	0.438	0.781	1.313	2 x 10-32 @ 90°

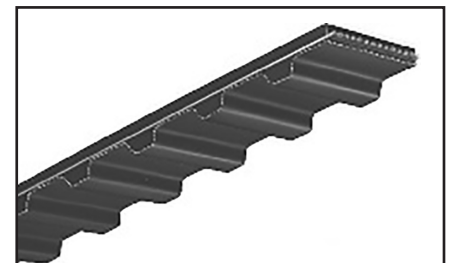
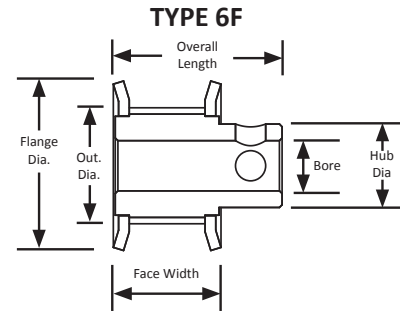

For matching XL pitch belts,
see page 20 in the MBL Industrial Catalog.

XL TIMING PULLEYS

0.200" Trapezoidal Pitch

For 3/8" Wide Belts

Hub and Flanges

Aluminum

Clear Anodized

Finished Bore

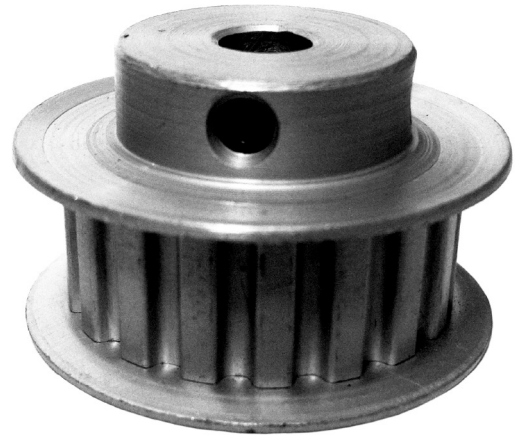

Part Number	No. of Teeth	Type	Pitch Dia. (in)	Out. Dia. (in)	Flange Dia. (in)	Bore (in)	Face Width (in)	Overall Length (in)	Hub Dia. (in)	Set Screw
10XL037-6FA2	10	6F	0.637	0.617	0.875	0.188	0.563	0.812	0.437	2 x 6-40 @ 90°
10XL037-6FA3	10	6F	0.637	0.617	0.875	0.250	0.563	0.812	0.437	2 x 8-32 @ 90°
11XL037-6FA2	11	6F	0.700	0.680	0.938	0.188	0.563	0.812	0.500	2 x 6-40 @ 90°
11XL037-6FA3	11	6F	0.700	0.680	0.938	0.250	0.563	0.812	0.500	2 x 8-32 @ 90°
12XL037-6FA2	12	6F	0.764	0.744	1.000	0.188	0.563	0.812	0.500	2 x 6-40 @ 90°
12XL037-6FA3	12	6F	0.764	0.744	1.000	0.250	0.563	0.812	0.500	2 x 8-32 @ 90°
12XL037-6FA4	12	6F	0.764	0.744	1.000	0.313	0.563	0.812	0.500	2 x 8-32 @ 90°
13XL037-6FA3	13	6F	0.828	0.808	1.063	0.250	0.563	0.812	0.563	2 x 8-32 @ 90°
13XL037-6FA4	13	6F	0.828	0.808	1.063	0.313	0.563	0.812	0.563	2 x 8-32 @ 90°
14XL037-6FA3	14	6F	0.891	0.871	1.094	0.250	0.563	0.812	0.563	2 x 8-32 @ 90°
14XL037-6FA4	14	6F	0.891	0.871	1.094	0.313	0.563	0.812	0.563	2 x 8-32 @ 90°
14XL037-6FA5	14	6F	0.891	0.871	1.094	0.375	0.563	0.812	0.563	2 x 8-32 @ 90°
15XL037-6FA3	15	6F	0.955	0.935	1.188	0.250	0.563	0.812	0.625	2 x 8-32 @ 90°
15XL037-6FA4	15	6F	0.955	0.935	1.188	0.313	0.563	0.812	0.625	2 x 8-32 @ 90°
15XL037-6FA5	15	6F	0.955	0.935	1.188	0.375	0.563	0.812	0.750	2 x 8-32 @ 90°
15XL037-6FA6	15	6F	0.955	0.935	1.188	0.500	0.563	0.812	0.750	2 x 8-32 @ 90°
16XL037-6FA3	16	6F	1.019	0.999	1.250	0.250	0.563	0.812	0.688	2 x 8-32 @ 90°
16XL037-6FA4	16	6F	1.019	0.999	1.250	0.313	0.563	0.812	0.688	2 x 8-32 @ 90°
16XL037-6FA5	16	6F	1.019	0.999	1.250	0.375	0.563	0.812	0.688	2 x 8-32 @ 90°
16XL037-6FA6	16	6F	1.019	0.999	1.250	0.500	0.563	0.812	0.688	2 x 8-32 @ 90°
17XL037-6FA3	17	6F	1.082	1.062	1.312	0.250	0.563	0.812	0.750	2 x 8-32 @ 90°
17XL037-6FA4	17	6F	1.082	1.062	1.312	0.313	0.563	0.812	0.750	2 x 8-32 @ 90°
17XL037-6FA5	17	6F	1.082	1.062	1.312	0.375	0.563	0.812	0.750	2 x 8-32 @ 90°
17XL037-6FA6	17	6F	1.082	1.062	1.312	0.500	0.563	0.812	0.750	2 x 8-32 @ 90°
18XL037-6FA3	18	6F	1.146	1.126	1.375	0.250	0.563	0.812	0.812	2 x 8-32 @ 90°
18XL037-6FA4	18	6F	1.146	1.126	1.375	0.313	0.563	0.812	0.812	2 x 8-32 @ 90°
18XL037-6FA5	18	6F	1.146	1.126	1.375	0.375	0.563	0.812	0.812	2 x 8-32 @ 90°

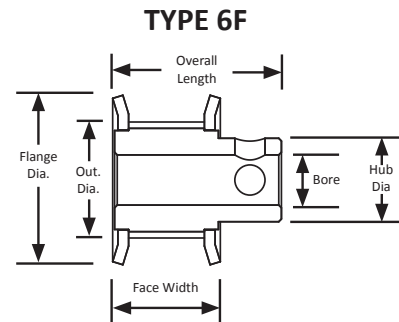

XL TIMING PULLEYS

0.200" Trapezoidal Pitch

For 3/8" Wide Belts

Hub and Flanges

Aluminum

Clear Anodized

Finished Bore

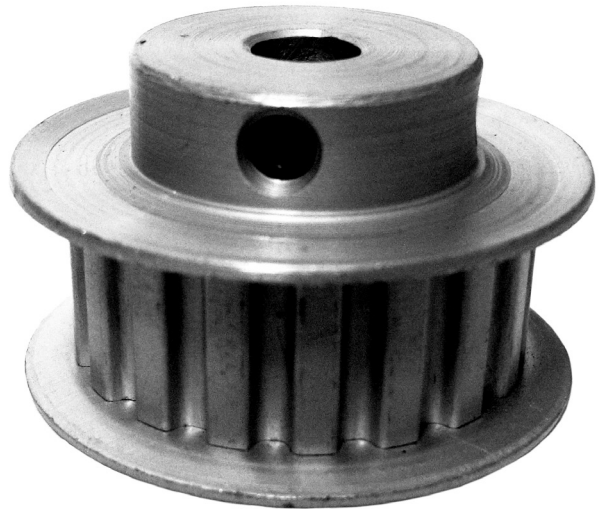

Part Number	No. of Teeth	Type	Pitch Dia. (in)	Out. Dia. (in)	Flange Dia. (in)	Bore (in)	Face Width (in)	Overall Length (in)	Hub Dia. (in)	Set Screw
18XL037-6FA6	18	6F	1.146	1.126	1.375	0.500	0.563	0.812	0.812	2 x 8-32 @ 90°
19XL037-6FA3	19	6F	1.210	1.190	1.437	0.250	0.563	0.812	0.875	2 x 8-32 @ 90°
19XL037-6FA4	19	6F	1.210	1.190	1.437	0.313	0.563	0.812	0.875	2 x 8-32 @ 90°
19XL037-6FA5	19	6F	1.210	1.190	1.437	0.375	0.563	0.812	0.875	2 x 8-32 @ 90°
19XL037-6FA6	19	6F	1.210	1.190	1.437	0.500	0.563	0.812	0.875	2 x 8-32 @ 90°
20XL037-6FA3	20	6F	1.273	1.253	1.500	0.250	0.563	0.875	0.937	2 x 8-32 @ 90°
20XL037-6FA4	20	6F	1.273	1.253	1.500	0.313	0.563	0.875	0.937	2 x 8-32 @ 90°
20XL037-6FA5	20	6F	1.273	1.253	1.500	0.375	0.563	0.875	0.937	2 x 10-32 @ 90°
20XL037-6FA6	20	6F	1.273	1.253	1.500	0.500	0.563	0.875	0.937	2 x 10-32 @ 90°
21XL037-6FA3	21	6F	1.337	1.317	1.563	0.250	0.563	0.875	1.000	2 x 8-32 @ 90°
21XL037-6FA4	21	6F	1.337	1.317	1.563	0.313	0.563	0.875	1.000	2 x 8-32 @ 90°
21XL037-6FA5	21	6F	1.337	1.317	1.563	0.375	0.563	0.875	1.000	2 x 10-32 @ 90°
21XL037-6FA6	21	6F	1.337	1.317	1.563	0.500	0.563	0.875	1.000	2 x 10-32 @ 90°
22XL037-6FA3	22	6F	1.401	1.381	1.625	0.250	0.563	0.875	1.000	2 x 8-32 @ 90°
22XL037-6FA4	22	6F	1.401	1.381	1.625	0.313	0.563	0.875	1.000	2 x 8-32 @ 90°
22XL037-6FA5	22	6F	1.401	1.381	1.625	0.375	0.563	0.875	1.000	2 x 10-32 @ 90°
22XL037-6FA6	22	6F	1.401	1.381	1.625	0.500	0.563	0.875	1.000	2 x 10-32 @ 90°
23XL037-6FA3	23	6F	1.464	1.444	1.688	0.250	0.563	0.875	1.063	2 x 8-32 @ 90°
23XL037-6FA4	23	6F	1.464	1.444	1.688	0.313	0.563	0.875	1.000	2 x 8-32 @ 90°
23XL037-6FA5	23	6F	1.464	1.444	1.688	0.375	0.563	0.875	1.000	2 x 10-32 @ 90°
24XL037-6FA3	24	6F	1.528	1.508	1.750	0.250	0.563	0.906	1.063	2 x 8-32 @ 90°
24XL037-6FA4	24	6F	1.528	1.508	1.750	0.313	0.563	0.906	1.063	2 x 8-32 @ 90°
24XL037-6FA5	24	6F	1.528	1.508	1.750	0.375	0.563	0.906	1.063	2 x 10-32 @ 90°
24XL037-6FA6	24	6F	1.528	1.508	1.750	0.500	0.563	0.906	1.063	2 x 10-32 @ 90°

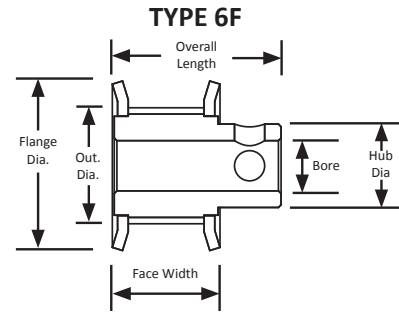

XL TIMING PULLEYS

0.200" Trapezoidal Pitch

For 3/8" Wide Belts

Hub and Flanges

Aluminum

Clear Anodized

Finished Bore

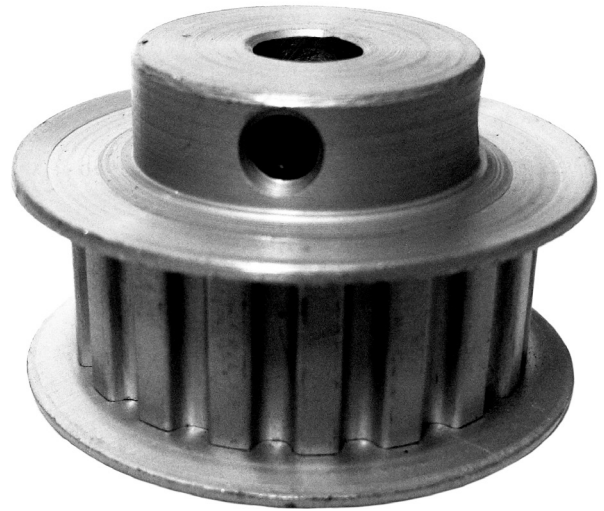

Part Number	No. of Teeth	Type	Pitch Dia. (in)	Out. Dia. (in)	Flange Dia. (in)	Bore (in)	Face Width (in)	Overall Length (in)	Hub Dia. (in)	Set Screw
25XL037-6FA3	25	6F	1.592	1.572	1.812	0.250	0.563	0.906	1.094	2 x 8-32 @ 90°
25XL037-6FA4	25	6F	1.592	1.572	1.812	0.313	0.563	0.906	1.094	2 x 8-32 @ 90°
25XL037-6FA5	25	6F	1.592	1.572	1.812	0.375	0.563	0.906	1.094	2 x 10-32 @ 90°
25XL037-6FA6	25	6F	1.592	1.572	1.812	0.500	0.563	0.906	1.094	2 x 10-32 @ 90°
26XL037-6FA3	26	6F	1.665	1.635	1.875	0.250	0.563	0.906	1.188	2 x 8-32 @ 90°
26XL037-6FA4	26	6F	1.665	1.635	1.875	0.313	0.563	0.906	1.188	2 x 8-32 @ 90°
26XL037-6FA5	26	6F	1.665	1.635	1.875	0.375	0.563	0.906	1.188	2 x 10-32 @ 90°
26XL037-6FA6	26	6F	1.665	1.635	1.875	0.500	0.563	0.906	1.188	2 x 10-32 @ 90°
28XL037-6FA3	28	6F	1.783	1.763	2.000	0.250	0.563	0.906	1.188	2 x 8-32 @ 90°
28XL037-6FA4	28	6F	1.783	1.763	2.000	0.313	0.563	0.906	1.188	2 x 8-32 @ 90°
28XL037-6FA5	28	6F	1.783	1.763	2.000	0.375	0.563	0.906	1.188	2 x 10-32 @ 90°
28XL037-6FA6	28	6F	1.783	1.763	2.000	0.500	0.563	0.906	1.188	2 x 10-32 @ 90°
28XL037-6FA7	28	6F	1.783	1.763	2.000	0.625	0.563	0.906	1.188	2 x 10-32 @ 90°
30XL037-6FA3	30	6F	1.910	1.890	2.125	0.250	0.563	0.906	1.312	2 x 8-32 @ 90°
30XL037-6FA4	30	6F	1.910	1.890	2.125	0.313	0.563	0.906	1.312	2 x 8-32 @ 90°
30XL037-6FA5	30	6F	1.910	1.890	2.125	0.375	0.563	0.906	1.312	2 x 10-32 @ 90°
30XL037-6FA6	30	6F	1.910	1.890	2.125	0.500	0.563	0.906	1.312	2 x 10-32 @ 90°
30XL037-6FA7	30	6F	1.910	1.890	2.125	0.625	0.563	0.906	1.312	2 x 10-32 @ 90°
32XL037-6FA3	32	6F	2.037	2.017	2.250	0.250	0.563	0.906	1.437	2 x 10-32 @ 90°
32XL037-6FA4	32	6F	2.037	2.017	2.250	0.313	0.563	0.906	1.437	2 x 10-32 @ 90°
32XL037-6FA5	32	6F	2.037	2.017	2.250	0.375	0.563	0.906	1.437	2 x 10-32 @ 90°
32XL037-6FA6	32	6F	2.037	2.017	2.250	0.500	0.563	0.906	1.437	2 x 10-32 @ 90°
32XL037-6FA7	32	6F	2.037	2.017	2.250	0.625	0.563	0.906	1.437	2 x 10-32 @ 90°

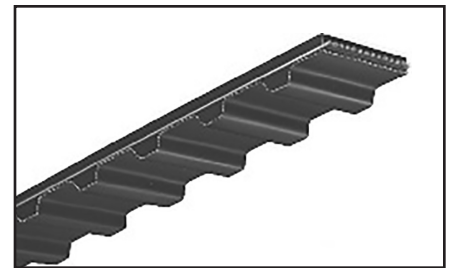
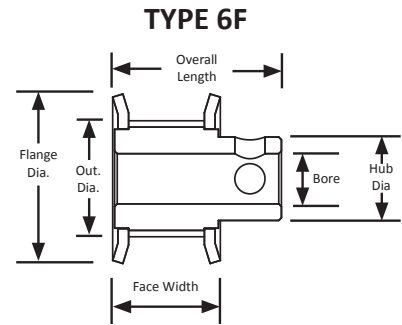

For matching XL pitch belts,
see page 20 in the MBL Industrial Catalog.

X TIMING PULLEYS

0.200" Trapezoidal Pitch

For 3/8" Wide Belts

Hub and No Flanges

Aluminum

Clear Anodized

Finished Bore



Part Number	No. of Teeth	Type	Pitch Dia. (in)	Out. Dia. (in)	Bore (in)	Face Width (in)	Overall Length (in)	Hub Dia. (in)	Set Screw
10XL037-6A2	10	6	0.637	0.617	0.188	0.563	0.812	0.437	2 x 6-40 @ 90°
11XL037-6A2	11	6	0.700	0.680	0.188	0.563	0.812	0.500	1 x 6-40 @ 90°
12XL037-6A2	12	6	0.764	0.744	0.188	0.563	0.812	0.563	2 x 6-40 @ 90°
13XL037-6A3	13	6	0.828	0.808	0.250	0.563	0.812	0.563	2 x 8-32 @ 90°
14XL037-6A3	14	6	0.891	0.871	0.250	0.563	0.812	0.625	2 x 8-32 @ 90°
15XL037-6A3	15	6	0.955	0.935	0.250	0.563	0.875	0.688	2 x 8-32 @ 90°
16XL037-6A3	16	6	1.019	0.999	0.250	0.563	0.875	0.750	2 x 8-32 @ 90°
17XL037-6A3	17	6	1.082	1.062	0.250	0.563	0.875	0.812	2 x 8-32 @ 90°
18XL037-6A3	18	6	1.146	1.126	0.250	0.563	0.875	0.875	2 x 8-32 @ 90°
19XL037-6A3	19	6	1.210	1.190	0.250	0.563	0.875	0.875	2 x 8-32 @ 90°
20XL037-6A3	20	6	1.273	1.253	0.250	0.563	0.937	0.938	2 x 8-32 @ 90°
21XL037-6A3	21	6	1.337	1.317	0.250	0.563	0.937	1.000	2 x 8-32 @ 90°
22XL037-6A3	22	6	1.401	1.381	0.250	0.563	0.937	1.063	2 x 8-32 @ 90°
23XL037-6A3	23	6	1.464	1.444	0.250	0.563	0.937	1.125	2 x 8-32 @ 90°
24XL037-6A3	24	6	1.528	1.508	0.250	0.563	0.937	1.188	2 x 8-32 @ 90°
24XL037-6A5	24	6	1.528	1.508	0.375	0.563	0.937	1.188	2 x 10-32 @ 90°
25XL037-6A3	25	6	1.592	1.572	0.250	0.563	0.937	1.250	2 x 8-32 @ 90°
26XL037-6A3	26	6	1.665	1.635	0.250	0.563	0.937	1.250	2 x 8-32 @ 90°
28XL037-6A3	28	6	1.783	1.763	0.250	0.563	0.937	1.250	2 x 8-32 @ 90°

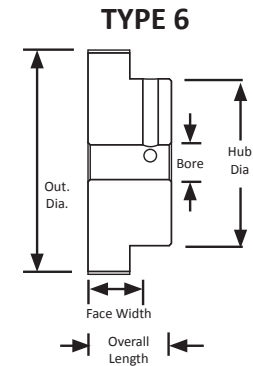

Have you ever wondered why there are timing pulleys without flanges?

When aligned properly, timing pulley flanges are only required on the smaller timing pulley of a synchronous belt drive when the distance between the centers of the two timing pulleys is less than 8 times the diameter of the smaller timing pulley. This allows for the larger timing pulley of the drive to be flangeless. A flangeless larger timing pulley saves the cost of the larger timing pulley flanges from the synchronous drive and allows for a little more clearance in tight fit applications.

PARALLEL MISALIGNMENT

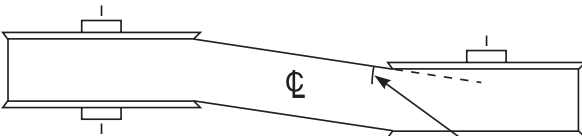

ANGULAR MISALIGNMENT

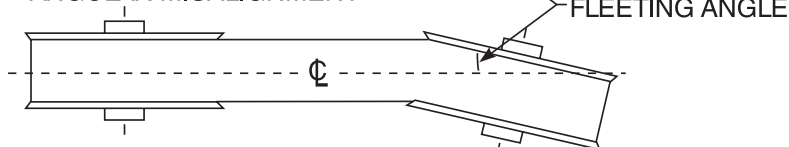

XL TIMING PULLEYS

0.200" Trapezoidal Pitch

For 3/8" Wide Belts

Hub and No Flanges

Aluminum

Clear Anodized

Finished Bore



Part Number	No. of Teeth	Type	Pitch Dia. (in)	Out. Dia. (in)	Bore (in)	Face Width (in)	Overall Length (in)	Hub Dia. (in)	Set Screw
30XL037-6A4	30	6	1.910	1.890	0.313	0.563	0.937	1.375	2 x 8-32 @ 90°
32XL037-6A4	32	6	2.037	2.017	0.313	0.563	1.000	1.500	2 x 8-32 @ 90°
32XL037-6A5	32	6	2.037	2.017	0.375	0.563	1.000	1.500	2 x 10-32 @ 90°
36XL037-6A4	36	6	2.292	2.272	0.313	0.563	1.000	1.500	2 x 8-32 @ 90°
36XL037-6A6	36	6	2.292	2.272	0.500	0.563	1.000	1.500	2 x 10-32 @ 90°
40XL037-6A4	40	6	2.546	2.526	0.313	0.563	1.000	1.500	2 x 8-32 @ 90°
40XL037-6A5	40	6	2.546	2.526	0.375	0.563	1.000	1.500	2 x 8-32 @ 90°
40XL037-6A6	40	6	2.546	2.526	0.500	0.563	1.000	1.500	2 x 8-32 @ 90°
42XL037-6A4	42	6	2.674	2.654	0.313	0.563	1.000	1.500	2 x 8-32 @ 90°
42XL037-6A5	42	6	2.674	2.654	0.375	0.563	1.000	1.500	2 x 8-32 @ 90°
44XL037-6A4	44	6	2.801	2.781	0.313	0.563	1.000	1.500	2 x 8-32 @ 90°
44XL037-6A5	44	6	2.801	2.781	0.375	0.563	1.000	1.500	2 x 10-32 @ 90°
48XL037-6A4	48	6	3.056	3.036	0.313	0.563	1.000	1.500	2 x 8-32 @ 90°
48XL037-6A5	48	6	3.056	3.036	0.375	0.563	1.000	1.500	2 x 10-32 @ 90°
48XL037-6A6	48	6	3.056	3.036	0.500	0.563	1.000	1.500	2 x 1/4-20 @ 90°
50XL037-6A4	50	6	3.183	3.163	0.313	0.563	1.000	1.500	2 x 8-32 @ 90°
50XL037-6WA4	50	6	3.183	3.163	0.313	0.563	1.000	1.500	2 x 10-32 @ 90°
50XL037-6A5	50	6	3.183	3.163	0.375	0.563	1.000	1.500	2 x 10-32 @ 90°
50XL037-6WA5	50	6	3.183	3.163	0.375	0.563	1.000	1.500	2 x 10-32 @ 90°
50XL037-6WA6	50	6	3.183	3.163	0.500	0.563	1.000	1.500	2 x 10-32 @ 90°
60XL037-6WA5	60	6W	3.820	3.800	0.375	0.563	1.000	1.500	2 x 10-32 @ 90°
60XL037-6WA6	60	6W	3.820	3.800	0.500	0.563	1.000	1.500	2 x 10-32 @ 90°
72XL037-6WA5	72	6W	4.584	4.564	0.375	0.563	1.000	1.500	2 x 10-32 @ 90°
72XL037-6WA6	72	6W	4.584	4.564	0.500	0.563	1.000	1.500	2 x 1/4-20 @ 90°
72XL037-6WA7	72	6W	4.584	4.564	0.625	0.563	1.000	1.500	2 x 10-32 @ 90°

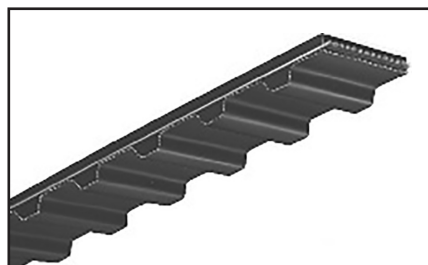
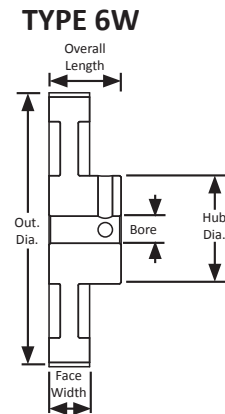
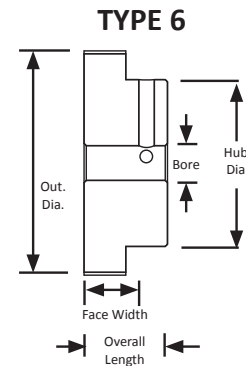

For matching XL pitch belts,
see page 20 in the MBL Industrial Catalog.

XL TIMING PULLEYS

0.200" Trapezoidal Pitch

For 3/8" Wide Belts

Hubless With Flanges

Aluminum

Clear Anodized

Finished Bore

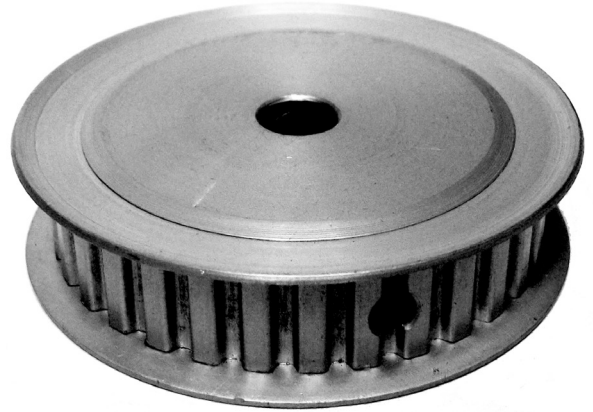

Part Number	No. of Teeth	Type	Pitch Dia. (in)	Out. Dia. (in)	Flange Dia. (in)	Bore (in)	Overall Length (in)	Set Screw
10XL037-3FA2	10	3F	0.637	0.617	0.875	0.188	0.563	2 x 6-32 @ 90°
10XL037-3FA3	10	3F	0.637	0.617	0.875	0.250	0.563	1 x 6-32
11XL037-3FA2	11	3F	0.700	0.680	0.938	0.188	0.563	1 x 6-32
11XL037-3FA3	11	3F	0.700	0.680	0.938	0.250	0.563	1 x 6-32
11XL037-3FA4	11	3F	0.700	0.680	0.938	0.313	0.563	1 x 6-32
12XL037-3FA2	12	3F	0.764	0.744	1.000	0.188	0.563	2 x 6-32 @ 90°
12XL037-3FA3	12	3F	0.764	0.744	1.000	0.250	0.563	2 x 6-32 @ 90°
12XL037-3FA4	12	3F	0.764	0.744	1.000	0.313	0.563	2 x 6-32 @ 90°
14XL037-3FA3	14	3F	0.891	0.871	1.094	0.250	0.563	2 x 8-32 @ 90°
14XL037-3FA4	14	3F	0.891	0.871	1.094	0.313	0.563	2 x 8-32 @ 90°
14XL037-3FA5	14	3F	0.891	0.871	1.094	0.375	0.563	2 x 8-32 @ 90°
15XL037-3FA3	15	3F	0.955	0.935	1.188	0.250	0.563	2 x 8-32 @ 90°
15XL037-3FA4	15	3F	0.955	0.935	1.188	0.313	0.563	2 x 8-32 @ 90°
15XL037-3FA5	15	3F	0.955	0.935	1.188	0.375	0.563	2 x 8-32 @ 90°
15XL037-3FA6	15	3F	0.955	0.935	1.188	0.500	0.563	2 x 8-32 @ 90°
16XL037-3FA3	16	3F	1.019	0.999	1.250	0.250	0.563	2 x 8-32 @ 90°
16XL037-3FA4	16	3F	1.019	0.999	1.250	0.313	0.563	2 x 8-32 @ 90°
16XL037-3FA5	16	3F	1.019	0.999	1.250	0.375	0.563	2 x 8-32 @ 90°
16XL037-3FA6	16	3F	1.019	0.999	1.250	0.500	0.563	2 x 8-32 @ 90°
18XL037-3FA3	18	3F	1.146	1.126	1.312	0.250	0.563	2 x 8-32 @ 90°
18XL037-3FA4	18	3F	1.146	1.126	1.312	0.313	0.563	2 x 8-32 @ 90°
18XL037-3FA5	18	3F	1.146	1.126	1.312	0.375	0.563	2 x 8-32 @ 90°
18XL037-3FA6	18	3F	1.146	1.126	1.312	0.500	0.563	2 x 8-32 @ 90°

TYPE 3F

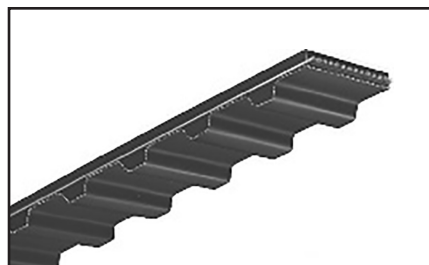
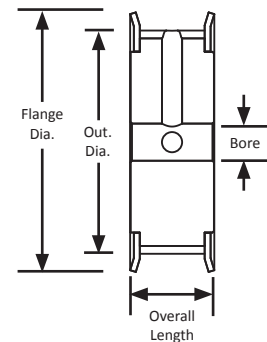

For matching XL pitch belts,
see page 20 in the MBL Industrial Catalog.

XL TIMING PULLEYS

0.200" Trapezoidal Pitch

For 3/8" Wide Belts

Hubless With Flanges

Aluminum

Clear Anodized

Finished Bore

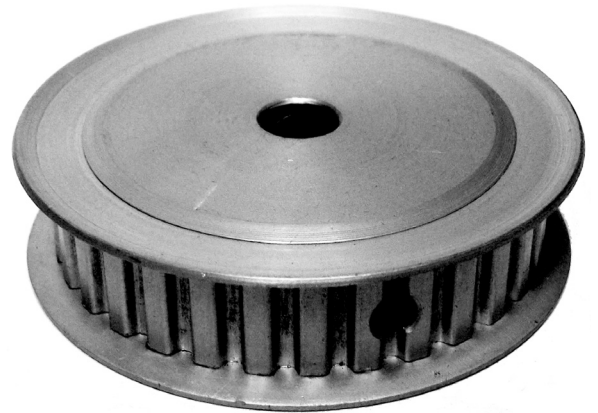

Part Number	No. of Teeth	Type	Pitch Dia. (in)	Out. Dia. (in)	Flange Dia. (in)	Bore (in)	Overall Length (in)	Set Screw
20XL037-3FA3	20	3F	1.273	1.253	1.500	0.250	0.563	2 x 8-32 @ 90°
20XL037-3FA4	20	3F	1.273	1.253	1.500	0.313	0.563	2 x 8-32 @ 90°
20XL037-3FA5	20	3F	1.273	1.253	1.500	0.375	0.563	2 x 8-32 @ 90°
20XL037-3FA6	20	3F	1.273	1.253	1.500	0.500	0.563	2 x 8-32 @ 90°
20XL037-3FA7	20	3F	1.273	1.253	1.500	0.625	0.563	2 x 8-32 @ 90°
21XL037-3FA3	21	3F	1.337	1.317	1.563	0.250	0.563	2 x 8-32 @ 90°
21XL037-3FA4	21	3F	1.337	1.317	1.563	0.313	0.563	2 x 8-32 @ 90°
21XL037-3FA5	21	3F	1.337	1.317	1.563	0.375	0.563	2 x 8-32 @ 90°
21XL037-3FA6	21	3F	1.337	1.317	1.563	0.500	0.563	2 x 8-32 @ 90°
22XL037-3FA3	22	3F	1.401	1.381	1.625	0.250	0.563	2 x 8-32 @ 90°
22XL037-3FA4	22	3F	1.401	1.381	1.625	0.313	0.563	2 x 8-32 @ 90°
22XL037-3FA5	22	3F	1.401	1.381	1.625	0.375	0.563	2 x 8-32 @ 90°
22XL037-3FA6	22	3F	1.401	1.381	1.625	0.500	0.563	2 x 8-32 @ 90°
24XL037-3FA3	24	3F	1.528	1.508	1.750	0.250	0.563	2 x 8-32 @ 90°
24XL037-3FA4	24	3F	1.528	1.508	1.750	0.313	0.563	2 x 8-32 @ 90°
24XL037-3FA5	24	3F	1.528	1.508	1.750	0.375	0.563	2 x 8-32 @ 90°
24XL037-3FA6	24	3F	1.528	1.508	1.750	0.500	0.563	2 x 8-32 @ 90°
28XL037-3FA3	28	3F	1.783	1.763	2.000	0.250	0.563	2 x 8-32 @ 90°
28XL037-3FA4	28	3F	1.783	1.763	2.000	0.313	0.563	2 x 8-32 @ 90°
28XL037-3FA5	28	3F	1.783	1.763	2.000	0.375	0.563	2 x 8-32 @ 90°
28XL037-3FA6	28	3F	1.783	1.763	2.000	0.500	0.563	2 x 8-32 @ 90°
30XL037-3FA3	30	3F	1.910	1.890	2.125	0.250	0.563	2 x 8-32 @ 90°
30XL037-3FA4	30	3F	1.910	1.890	2.125	0.313	0.563	2 x 8-32 @ 90°
30XL037-3FA5	30	3F	1.910	1.890	2.125	0.375	0.563	2 x 8-32 @ 90°
30XL037-3FA6	30	3F	1.910	1.890	2.125	0.500	0.563	2 x 8-32 @ 90°
30XL037-3FA7	30	3F	1.910	1.890	2.125	0.625	0.563	2 x 8-32 @ 90°
32XL037-3FA3	32	3F	2.037	2.017	2.250	0.250	0.563	2 x 8-32 @ 90°
32XL037-3FA4	32	3F	2.037	2.017	2.250	0.313	0.563	2 x 8-32 @ 90°
32XL037-3FA5	32	3F	2.037	2.017	2.250	0.375	0.563	2 x 8-32 @ 90°
32XL037-3FA6	32	3F	2.037	2.017	2.250	0.500	0.563	2 x 8-32 @ 90°
32XL037-3FA7	32	3F	2.037	2.017	2.250	0.625	0.563	2 x 8-32 @ 90°

TYPE 3F

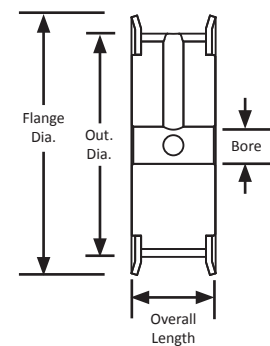

XL TIMING PULLEYS

0.200" Trapezoidal Pitch

For 3/8" Wide Belts

Hub and Flanges

Steel

Black Oxide Plating

Finished Bore



Part Number	No. of Teeth	Type	Pitch Dia. (in)	Out. Dia. (in)	Flange Dia. (in)	Bore (in)	Face Width (in)	Overall Length (in)	Hub Dia. (in)	Set Screw
10XL037-6FS2	10	6F	0.637	0.617	0.875	0.188	0.563	0.812	0.437	2 x 6-40 @ 90°
10XL037-6FS3	10	6F	0.637	0.617	0.875	0.250	0.563	0.812	0.437	2 x 8-32 @ 90°
11XL037-6FS2	11	6F	0.700	0.680	0.937	0.188	0.563	0.812	0.500	2 x 6-40 @ 90°
11XL037-6FS3	11	6F	0.700	0.680	0.937	0.250	0.563	0.812	0.500	2 x 8-32 @ 90°
12XL037-6FS2	12	6F	0.764	0.744	1.000	0.188	0.563	0.812	0.500	2 x 6-40 @ 90°
12XL037-6FS3	12	6F	0.764	0.744	1.000	0.250	0.563	0.812	0.500	2 x 8-32 @ 90°
12XL037-6FS4	12	6F	0.764	0.744	1.000	0.313	0.563	0.812	0.500	2 x 8-32 @ 90°
14XL037-6FS3	14	6F	0.891	0.871	1.094	0.250	0.563	0.812	0.563	2 x 8-32 @ 90°
14XL037-6FS4	14	6F	0.891	0.871	1.094	0.313	0.563	0.812	0.563	2 x 8-32 @ 90°
15XL037-6FS3	15	6F	0.955	0.935	1.188	0.250	0.563	0.812	0.625	2 x 8-32 @ 90°
15XL037-6FS4	15	6F	0.955	0.935	1.188	0.313	0.563	0.812	0.625	2 x 8-32 @ 90°
15XL037-6FS5	15	6F	0.955	0.935	1.188	0.375	0.563	0.812	0.750	2 x 8-32 @ 90°
15XL037-6FS6	15	6F	0.955	0.935	1.188	0.500	0.563	0.812	0.750	2 x 8-32 @ 90°
16XL037-6FS3	16	6F	1.019	0.999	1.250	0.250	0.563	0.812	0.688	2 x 8-32 @ 90°
16XL037-6FS4	16	6F	1.019	0.999	1.250	0.313	0.563	0.812	0.688	2 x 8-32 @ 90°
16XL037-6FS5	16	6F	1.019	0.999	1.250	0.375	0.563	0.812	0.688	2 x 8-32 @ 90°
18XL037-6FS3	18	6F	1.146	1.126	1.375	0.250	0.563	0.812	0.812	2 x 8-32 @ 90°
18XL037-6FS4	18	6F	1.146	1.126	1.375	0.313	0.563	0.812	0.812	2 x 8-32 @ 90°
18XL037-6FS5	18	6F	1.146	1.126	1.375	0.375	0.563	0.812	0.812	2 x 8-32 @ 90°
18XL037-6FS6	18	6F	1.146	1.126	1.375	0.500	0.563	0.812	0.812	2 x 8-32 @ 90°

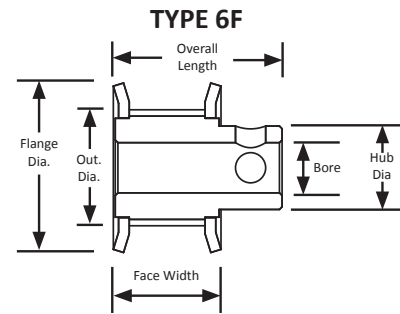

The XL pitch is an imperial pitch which is based on the "inch" system of measurement. The imperial pitch tooth profile is a commonly found profile and is trapezoidal in shape. Imperial pitch pulley part numbers can tell you a great deal about the pulley including the number of teeth, pitch, belt width, unit of measure, appearance, material, and bore size. For more information on part numbers and their meaning, see page 1.

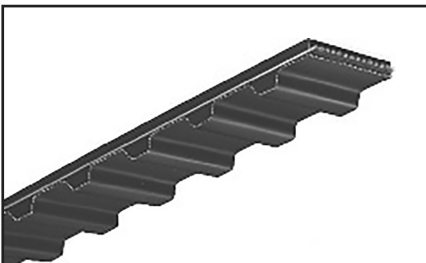

For matching XL pitch belts, see page 20 in the MBL Industrial Catalog.

XL TIMING PULLEYS

0.200" Trapezoidal Pitch

For 3/8" Wide Belts

Hub

Steel

Black Oxide Plating

Finished Bore



Part Number	No. of Teeth	Type	Pitch Dia. (in)	Out. Dia. (in)	Flange Dia. (in)	Bore (in)	Face Width (in)	Overall Length (in)	Hub Dia. (in)	Set Screw
20XL037-6FS3	20	6F	1.273	1.253	1.500	0.250	0.563	0.875	0.937	2 x 8-32 @ 90°
20XL037-6FS4	20	6F	1.273	1.253	1.500	0.313	0.563	0.875	0.937	2 x 8-32 @ 90°
20XL037-6FS5	20	6F	1.273	1.253	1.500	0.375	0.563	0.875	0.937	2 x 10-32 @ 90°
20XL037-6FS6	20	6F	1.273	1.253	1.500	0.500	0.563	0.875	0.937	2 x 10-32 @ 90°
21XL037-6FS3	21	6F	1.337	1.317	1.563	0.250	0.563	0.875	1.000	2 x 8-32 @ 90°
22XL037-6FS3	22	6F	1.401	1.381	1.625	0.250	0.563	0.875	1.000	2 x 8-32 @ 90°
22XL037-6FS4	22	6F	1.401	1.381	1.625	0.313	0.563	0.875	1.000	2 x 8-32 @ 90°
22XL037-6FS5	22	6F	1.401	1.381	1.625	0.375	0.563	0.875	1.000	2 x 10-32 @ 90°
22XL037-6FS6	22	6F	1.401	1.381	1.625	0.500	0.563	0.875	1.000	2 x 10-32 @ 90°
24XL037-6FS3	24	6F	1.528	1.508	1.750	0.250	0.563	0.906	1.063	2 x 8-32 @ 90°
24XL037-6FS4	24	6F	1.528	1.508	1.750	0.313	0.563	0.906	1.063	2 x 8-32 @ 90°
24XL037-6FS5	24	6F	1.528	1.508	1.750	0.375	0.563	0.906	1.063	2 x 10-32 @ 90°
24XL037-6FS6	24	6F	1.528	1.508	1.750	0.500	0.563	0.906	1.063	2 x 10-32 @ 90°
28XL037-6FS3	28	6F	1.783	1.763	2.000	0.250	0.563	0.906	1.188	2 x 8-32 @ 90°
28XL037-6FS4	28	6F	1.783	1.763	2.000	0.313	0.563	0.906	1.188	2 x 8-32 @ 90°
28XL037-6FS5	28	6F	1.783	1.763	2.000	0.375	0.563	0.906	1.188	2 x 10-32 @ 90°
28XL037-6FS6	28	6F	1.783	1.763	2.000	0.500	0.563	0.906	1.188	2 x 10-32 @ 90°
30XL037-6FS4	30	6F	1.910	1.890	2.125	0.313	0.563	0.906	1.312	2 x 8-32 @ 90°
30XL037-6FS5	30	6F	1.910	1.890	2.125	0.375	0.563	0.906	1.312	2 x 10-32 @ 90°
32XL037-6S4	32	6	2.037	2.017	-	0.313	0.563	1.000	1.500	2 X 1/4-20 @ 90°
36XL037-6S4	36	6	2.292	2.272	-	0.313	0.563	1.000	1.500	2 X 1/4-20 @ 90°
40XL037-6S4	40	6	2.546	2.526	-	0.313	0.563	1.000	1.500	2 X 1/4-20 @ 90°
42XL037-6S4	42	6	2.674	2.654	-	0.313	0.563	1.000	1.500	2 X 1/4-20 @ 90°
44XL037-6S4	44	6	2.801	2.781	-	0.313	0.563	1.000	1.500	2 X 1/4-20 @ 90°
48XL037-6S4	48	6	3.056	3.036	-	0.313	0.563	1.000	1.500	2 X 1/4-20 @ 90°
60XL037-6S5	60	6	3.820	3.800	-	0.375	0.563	1.000	1.500	2 X 1/4-20 @ 90°
72XL037-6S5	72	6	4.584	4.564	-	0.375	0.563	1.000	1.500	2 X 1/4-20 @ 90°

TYPE 6F

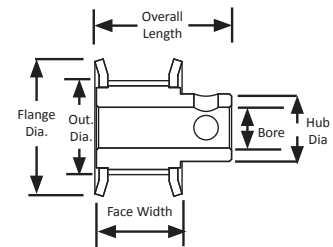

TYPE 6

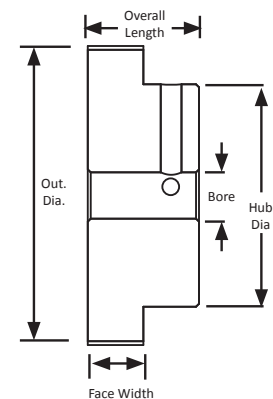

XL TIMING PULLEYS

METRIC TIMING PULLEY

0.200" Trapezoidal Pitch

For 6mm Wide Belts

Hub and Flanges

Aluminum

Clear Anodized

Metric Finished Bores

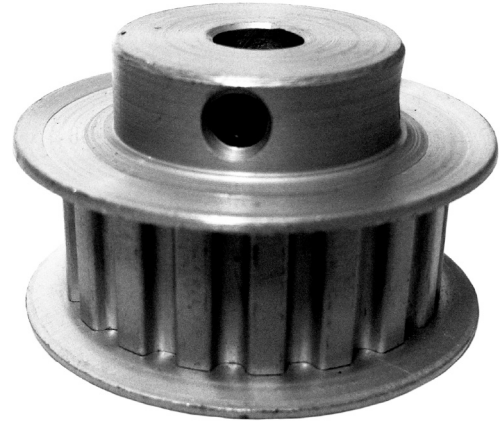

Part Number	No. of Teeth	Type	Pitch Dia. (mm)	Out. Dia. (mm)	Flange Dia. (mm)	Bore (mm)	Face Width (mm)	Overall Length (mm)	Hub Dia. (mm)	Set Screw
10XL025M6FA6	10	6F	16.2	15.7	22.0	6.0	11.1	17.5	10.0	M3
11XL025M6FA6	11	6F	17.8	17.3	24.0	6.0	11.1	17.5	11.0	M3
12XL025M6FA6	12	6F	19.4	18.9	25.0	6.0	11.1	17.5	13.0	2 x M3 @ 90°
14XL025M6FA8	14	6F	22.6	22.1	28.0	8.0	11.1	17.5	14.0	2 x M4 @ 90°
15XL025M6FA8	15	6F	24.3	23.7	30.0	8.0	11.1	17.5	16.0	2 x M4 @ 90°
16XL025M6FA8	16	6F	25.9	25.4	32.0	8.0	11.1	17.5	17.0	2 x M4 @ 90°
18XL025M6FA8	18	6F	29.1	28.6	35.0	8.0	11.1	17.5	21.0	2 x M4 @ 90°
20XL025M6FA8	20	6F	32.3	31.8	38.0	8.0	11.1	19.1	24.0	2 x M4 @ 90°
22XL025M6FA8	22	6F	35.6	35.1	41.0	8.0	11.1	19.1	25.0	2 x M4 @ 90°
24XL025M6FA8	24	6F	38.8	38.3	44.0	8.0	11.1	19.8	27.0	2 x M4 @ 90°
28XL025M6FA8	28	6F	45.3	44.8	51.0	8.0	11.1	19.8	30.0	2 x M4 @ 90°
30XL025M6FA8	30	6F	48.5	48.0	54.0	8.0	11.1	19.8	33.0	2 x M4 @ 90°

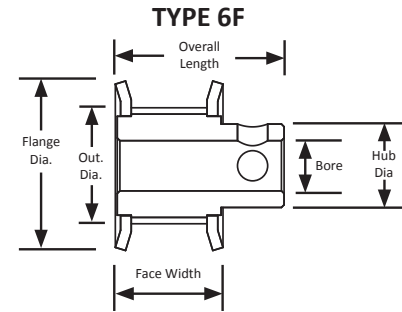

Plain bores, often referred to as minimum plain bores or MPB, are simply untapered bores drilled through the center of a pulley, gear, sprocket, or sheave. Sometimes component part numbers use MPB to designate the plain bore style. Finished bores are plain bores with the addition of either a keyway, set screws, or both. Timing pulleys and roller chain sprockets often use a F in the part number to illustrate a finished bore.

A keyway is a slot cut into a pulley, gear, sprocket, or sheave to accept a key that engages with a similar slot on a shaft to prohibit the relative motion of the two components. Keys connecting shafts to pulley hubs are commonly used to achieve reliable no-slip power transmission in belt drive systems. A set screw is a screw through the pulley, gear, sprocket, or sheave used to tighten the component to the shaft and limit slippage. Typically, set screws are used on larger diameter components as they typically transmit higher loads.

There are some advantages to having a plain bore. With a plain bore, it is easier to customize how the component is affixed to the shaft. A plain bore can be opened to a larger bore diameter, can be made into a finished bore, or can even be customized in other ways such as incorporating pins or screws. There are also advantages to having a finished bore. The most noteworthy advantage is the increased prevention of shaft slippage. It allows for the component to move larger loads with increased accuracy. A noteworthy disadvantage is in the food and beverage industry where set screw holes will at times fill with debris depending on the application.

XL TIMING PULLEYS

METRIC TIMING PULLEY

0.200" Trapezoidal Pitch

For 9.5mm Wide Belts

Hub and Flanges

Aluminum

Clear Anodized

Metric Finished Bores

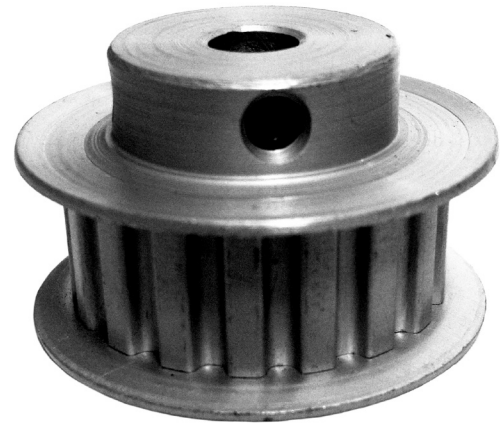

Part Number	No. of Teeth	Type	Pitch Dia. (mm)	Out. Dia. (mm)	Flange Dia. (mm)	Bore (mm)	Face Width (mm)	Overall Length (mm)	Belt Width (mm)	Hub Dia. (mm)	Set Screw
10XL037M6FA6	10	6F	16.2	15.7	22.0	6.0	14.2	20.6	10.9	10.0	M3
11XL037M6FA6	11	6F	17.8	17.3	24.0	6.0	14.2	20.6	10.9	11.0	M3
12XL037M6FA6	12	6F	19.4	18.9	25.0	6.0	14.2	20.6	10.9	13.0	2 x M3 @ 90°
14XL037M6FA8	14	6F	22.6	22.1	28.0	8.0	14.2	20.6	10.9	14.0	2 x M4 @ 90°
15XL037M6FA8	15	6F	24.3	23.7	30.0	8.0	14.2	20.6	10.9	16.0	2 x M4 @ 90°
16XL037M6FA8	16	6F	25.9	25.4	32.0	8.0	14.2	20.6	10.9	17.0	2 x M4 @ 90°
18XL037M6FA8	18	6F	29.1	28.6	35.0	8.0	14.2	20.6	10.9	21.0	2 x M4 @ 90°
20XL037M6FA8	20	6F	32.3	31.8	38.0	8.0	14.2	22.2	10.9	24.0	2 x M4 @ 90°
22XL037M6FA8	22	6F	25.6	35.1	41.0	8.0	14.2	22.2	10.9	25.0	2 x M4 @ 90°
24XL037M6FA8	24	6F	38.8	38.3	44.0	8.0	14.2	22.2	10.9	27.0	2 x M4 @ 90°
28XL037M6FA8	28	6F	45.4	44.8	51.0	8.0	14.2	23.0	10.9	30.0	2 x M4 @ 90°
30XL037M6FA10	30	6F	48.5	48.0	54.0	10.0	14.2	23.0	10.9	33.0	2 x M5 @ 90°
32XL037M6FA12	32	6F	51.7	51.2	57.0	12.0	14.2	23.0	10.9	37.0	2 x M6 @ 90°

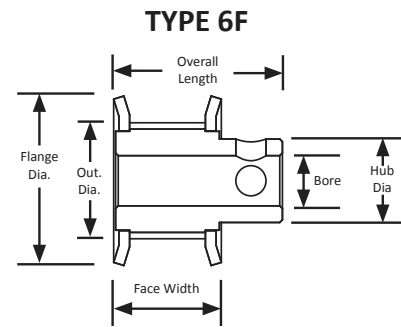

XL TIMING PULLEYS

METRIC TIMING PULLEY

0.200" Trapezoidal Pitch

For 9.5mm Wide Belts

Hub and No Flanges

Aluminum

Clear Anodized

Metric Finished Bore



Part Number	No. of Teeth	Type	Pitch Dia. (mm)	Out. Dia. (mm)	Flange Dia. (mm)	Bore (mm)	Face Width (mm)	Overall Length (mm)	Hub Dia. (mm)	Set Screw
10XL037M6A6	10	6	16.2	15.7	6.0	14.3	20.6	9.5	11.0	M3
11XL037M6A6	11	6	17.8	17.3	6.0	14.3	20.6	9.5	13.0	M3
12XL037M6A6	12	6	19.4	18.9	6.0	14.3	20.6	9.5	14.0	2 x M3 @ 90°
14XL037M6A8	14	6	22.6	22.1	8.0	14.3	20.6	9.5	16.0	2 x M4 @ 90°
15XL037M6A8	15	6	24.3	23.7	8.0	14.3	22.2	9.5	17.0	2 x M4 @ 90°
16XL037M6A8	16	6	25.9	25.4	8.0	14.3	22.2	9.5	19.0	2 x M4 @ 90°
18XL037M6A8	18	6	29.1	28.6	8.0	14.3	22.2	9.5	22.0	2 x M4 @ 90°
20XL037M6A8	20	6	32.3	31.8	8.0	14.3	23.8	9.5	24.0	2 x M4 @ 90°
22XL037M6A8	22	6	35.6	35.1	8.0	14.3	23.8	9.5	27.0	2 x M4 @ 90°
24XL037M6A8	24	6	38.8	38.3	8.0	14.3	23.8	9.5	30.0	2 x M4 @ 90°
28XL037M6A8	28	6	45.3	44.8	8.0	14.3	23.8	9.5	32.0	2 x M4 @ 90°
30XL037M6A10	30	6	48.5	48.0	10.0	14.3	23.8	9.5	35.0	2 x M5 @ 90°
32XL037M6A10	32	6	51.7	51.2	10.0	14.3	25.4	9.5	38.0	2 x M5 @ 90°
36XL037M6A10	36	6	58.2	57.7	10.0	14.3	25.4	9.5	38.0	2 x M5 @ 90°
40XL037M6A10	40	6	64.7	64.2	10.0	14.3	25.4	9.5	38.0	2 x M5 @ 90°
42XL037M6A10	42	6	67.9	67.4	10.0	14.3	25.4	9.5	38.0	2 x M5 @ 90°
44XL037M6A10	44	6	71.1	70.6	10.0	14.3	25.4	9.5	38.0	2 x M5 @ 90°
48XL037M6A12	48	6	77.6	77.1	12.0	14.3	25.4	9.5	38.0	2 x M6 @ 90°
60XL037M6WA12	60	6W	97.0	96.5	12.0	14.3	25.4	9.5	38.0	2 x M6 @ 90°
72XL037M6WA12	72	6W	116.4	115.9	12.0	14.3	25.4	9.5	38.0	2 x M6 @ 90°

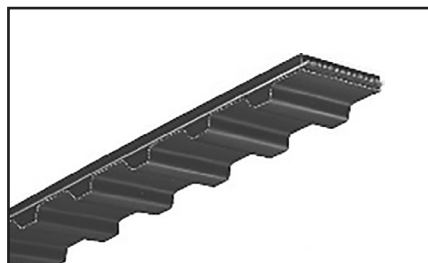
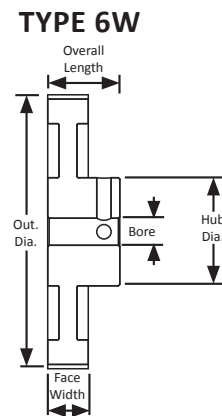
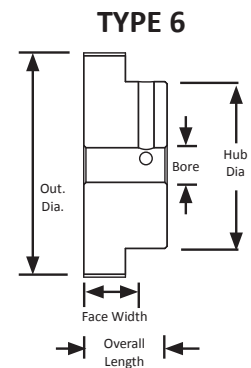

For matching XL pitch belts,
see page 20 in the MBL Industrial Catalog.

XL TIMING PULLEYS

METRIC TIMING PULLEY

0.200" Trapezoidal Pitch

For 9.5mm Wide Belts

Hubless with Flanges

Aluminum

Clear Anodized

Metric Finished Bore

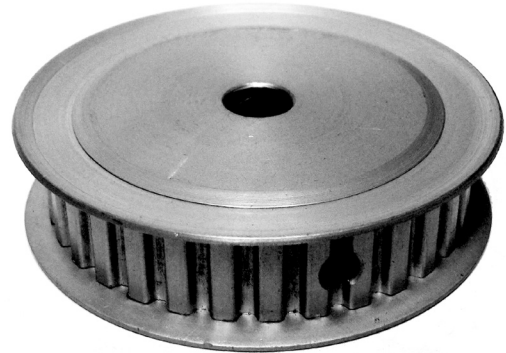

Part Number	No. of Teeth	Type	Pitch Dia. (mm)	Out. Dia. (mm)	Flange Dia. (mm)	Bore (mm)	Face Width (mm)	Overall Length (mm)	Set Screw
10XL037M3FA6	10	3F	16.2	15.7	22.0	6.0	14.2	14.2	M3
11XL037M3FA6	11	3F	17.8	17.3	24.0	6.0	14.2	14.2	M3
12XL037M3FA6	12	3F	19.4	18.9	25.0	6.0	14.2	14.2	2 x M3 @ 90°
14XL037M3FA8	14	3F	22.6	22.1	28.0	8.0	14.2	14.2	2 x M4 @ 90°
15XL037M3FA8	15	3F	24.3	23.7	30.0	8.0	14.2	14.2	2 x M4 @ 90°
16XL037M3FA8	16	3F	25.9	25.4	32.0	8.0	14.2	14.2	2 x M4 @ 90°
18XL037M3FA8	18	3F	29.1	28.6	35.0	8.0	14.2	14.2	2 x M4 @ 90°
20XL037M3FA8	20	3F	32.3	31.8	38.0	8.0	14.2	14.2	2 x M4 @ 90°
22XL037M3FA8	22	3F	35.6	35.1	41.0	8.0	14.2	14.2	2 x M4 @ 90°
24XL037M3FA8	24	3F	38.8	38.3	44.0	8.0	14.2	14.2	2 x M4 @ 90°
28XL037M3FA8	28	3F	45.3	44.8	51.0	8.0	14.2	14.2	2 x M4 @ 90°
30XL037M3FA8	30	3F	48.5	48.0	54.0	8.0	14.2	14.2	2 x M4 @ 90°

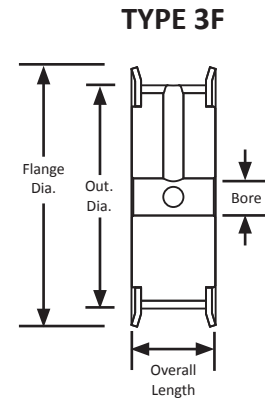

L TIMING PULLEYS

0.375" Trapezoidal Pitch

For 1/2" Wide Belts

Hub and Flanges

Aluminum

Clear Anodized

Finished Bore



Part Number	No. of Teeth	Type	Pitch Dia. (in)	Out. Dia. (in)	Flange Dia. (in)	Bore (in)	Face Width (in)	Overall Length (in)	Hub Dia. (in)	Set Screw
10L050-6FA5	10	6F	1.194	1.164	1.438	0.375	0.719	1.125	0.875	2 x 10-32 @ 90°
10L050-6FA6	10	6F	1.194	1.164	1.438	0.500	0.719	1.125	0.875	2 x 1/4-20 @ 90°
12L050-6FA5	12	6F	1.432	1.402	1.656	0.375	0.719	1.188	1.125	2 x 10-32 @ 90°
12L050-6FA6	12	6F	1.432	1.402	1.656	0.500	0.719	1.188	1.125	2 x 1/4-20 @ 90°
13L050-6FA5	13	6F	1.552	1.522	1.781	0.375	0.719	1.188	1.125	2 x 10-32 @ 90°
13L050-6FA6	13	6F	1.552	1.522	1.781	0.500	0.719	1.188	1.125	2 x 1/4-20 @ 90°
14L050-6FA5	14	6F	1.671	1.641	1.906	0.375	0.719	1.188	1.250	2 x 10-32 @ 90°
14L050-6FA6	14	6F	1.671	1.641	1.906	0.500	0.719	1.188	1.250	2 x 1/4-20 @ 90°
15L050-6FA5	15	6F	1.790	1.760	2.031	0.375	0.719	1.250	1.375	2 x 10-32 @ 90°
15L050-6FA6	15	6F	1.790	1.760	2.031	0.500	0.719	1.250	1.375	2 x 1/4-20 @ 90°
16L050-6FA6	16	6F	1.910	1.880	2.125	0.500	0.719	1.250	1.375	2 x 1/4-20 @ 90°
17L050-6FA6	17	6F	2.029	1.999	2.250	0.500	0.719	1.250	1.500	2 x 1/4-20 @ 90°
18L050-6FA6	18	6F	2.149	2.119	2.375	0.500	0.719	1.250	1.625	2 x 1/4-20 @ 90°
19L050-6FA6	19	6F	2.268	2.238	2.500	0.500	0.719	1.312	1.688	2 x 1/4-20 @ 90°
20L050-6FA6	20	6F	2.387	2.357	2.625	0.500	0.719	1.312	1.812	2 x 1/4-20 @ 90°
21L050-6FA6	21	6F	2.507	2.477	2.750	0.500	0.719	1.375	2.000	2 x 1/4-20 @ 90°
22L050-6FA6	22	6F	2.626	2.596	2.875	0.500	0.719	1.375	2.125	2 x 1/4-20 @ 90°
24L050-6FA6	24	6F	2.865	2.835	3.094	0.500	0.719	1.375	2.250	2 x 1/4-20 @ 90°
26L050-6FA6	26	6F	3.104	3.074	3.330	0.500	0.750	1.375	2.250	2 x 1/4-20 @ 90°
28L050-6FA6	28	6F	3.342	3.312	3.566	0.500	0.750	1.375	2.250	2 x 1/4-20 @ 90°
30L050-6FA6	30	6F	3.581	3.551	3.800	0.500	0.750	1.375	2.250	2 x 1/4-20 @ 90°
32L050-6FA6	32	6F	3.820	3.790	4.044	0.500	0.750	1.375	2.625	2 x 1/4-20 @ 90°
36L050-6FA6	36	6F	4.297	4.267	4.520	0.500	0.750	1.375	3.500	2 x 1/4-20 @ 90°
40L050-6FA6	40	6F	4.775	4.745	5.000	0.500	0.750	1.375	3.625	2 x 1/4-20 @ 90°

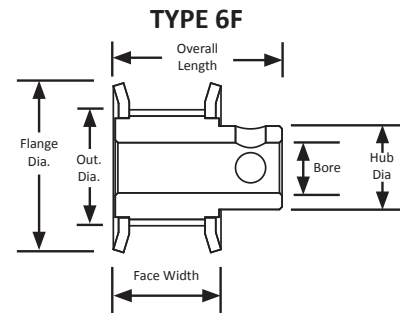

The L pitch is an imperial pitch which is based on the "inch" system of measurement. The imperial pitch tooth profile is a commonly found profile and is trapezoidal in shape. Imperial pitch pulley part numbers can tell you a great deal about the pulley including the number of teeth, pitch, belt width, unit of measure, appearance, material, and bore size.

For more information on part numbers and their meaning, see page 1.

L TIMING PULLEYS

0.375" Trapezoidal Pitch

For 1/2" Wide Belts

Hub and Flanges

Steel/Iron

Black Oxide Plating

Minimum Plain Bore



Part Number	No. of Teeth	Type	Pitch Dia (in)	Out. Dia (in)	Flange Dia. (in)	Bore (in)	Face Width (in)	Overall Length (in)	Hub Dia. (in)
10L050-6FS5	10	6F	1.194	1.164	1.438	0.375	0.750	1.250	0.812
12L050-6FS5	12	6F	1.432	1.402	1.656	0.375	0.750	1.250	1.000
13L050-6FS5	13	6F	1.552	1.522	1.781	0.375	0.750	1.250	1.125
14L050-6FS5	14	6F	1.671	1.641	1.906	0.375	0.750	1.250	1.125
15L050-6FS6	15	6F	1.790	1.760	2.031	0.500	0.750	1.250	1.344
16L050-6FS6	16	6F	1.910	1.880	2.125	0.500	0.750	1.250	1.437
17L050-6FS6	17	6F	2.029	1.999	2.250	0.500	0.750	1.250	1.437
18L050-6FS6	18	6F	2.149	2.119	2.375	0.500	0.750	1.250	1.563
19L050-6FS6	19	6F	2.268	2.238	2.500	0.500	0.750	1.250	1.687
20L050-6FS6	20	6F	2.387	2.357	2.625	0.500	0.750	1.250	1.687
21L050-6FS6	21	6F	2.507	2.477	2.750	0.500	0.750	1.250	2.000
22L050-6FS6	22	6F	2.626	2.596	2.875	0.500	0.750	1.250	2.000
24L050-6FS6	24	6F	2.865	2.835	3.094	0.500	0.750	1.250	2.250
26L050-6FS6	26	6F	3.104	3.074	3.330	0.500	0.750	1.250	2.250
28L050-6FS6	28	6F	3.342	3.312	3.566	0.500	0.750	1.250	2.250
30L050-6FS6	30	6F	3.581	3.551	3.800	0.500	0.750	1.250	2.250
32L050-6FS6	32	6F	3.820	3.790	4.044	0.500	0.750	1.250	2.625
36L050-6FS6	36	6F	4.297	4.267	4.520	0.500	0.750	1.250	3.500
40L050-6FS6	40	6F	4.775	4.745	5.000	0.500	0.750	1.250	3.625

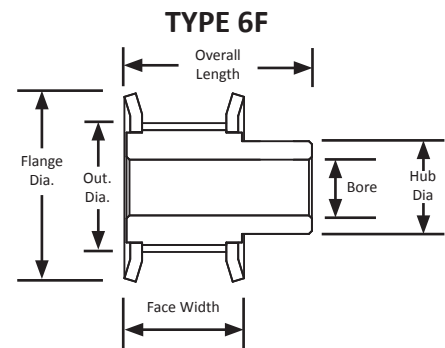

PARALLEL MISALIGNMENT

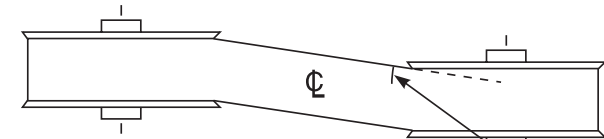

ANGULAR MISALIGNMENT

FLEETING ANGLE

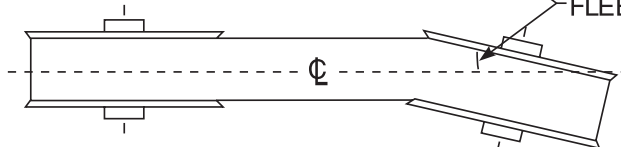

L TIMING PULLEYS

0.375" Trapezoidal Pitch

For 0.500" Wide Belts

Hub and Flanges

Steel

Black Oxide Plating

Finished Bore



Note: Pulleys with bores 0.500" or less have set screws.
Pulleys with bores greater than 0.500" have keyways and set screws.

Part Number	No. of Teeth	Type	Pitch Dia. (in)	Out. Dia. (in)	Flange Dia. (in)	Bore (in)	Face Width (in)	Overall Length (in)	Hub Dia. (in)	Set Screw
10LF050X3/8	10	6F	1.194	1.164	1.438	0.375	0.750	1.250	0.812	1 x 1/4-20
12LF050X3/8	12	6F	1.432	1.402	1.656	0.375	0.750	1.250	1.000	1 x 1/4-20
12LF050X1/2	12	6F	1.432	1.402	1.656	0.500	0.750	1.250	1.000	1 x 1/4-20
13LF050X3/8	13	6F	1.552	1.522	1.781	0.375	0.750	1.250	1.125	1 x 1/4-20
13LF050X1/2	13	6F	1.552	1.522	1.781	0.500	0.750	1.250	1.125	1 x 1/4-20
14LF050X3/8	14	6F	1.671	1.641	1.906	0.375	0.750	1.250	1.125	1 x 1/4-20
14LF050X1/2	14	6F	1.671	1.641	1.906	0.500	0.750	1.250	1.125	1 x 1/4-20
15LF050X1/2	15	6F	1.790	1.760	2.031	0.500	0.750	1.250	1.344	1 x 1/4-20
15LF050X5/8	15	6F	1.790	1.760	2.031	0.625	0.750	1.250	1.344	1 x 1/4-20
15LF050X3/4	15	6F	1.790	1.760	2.031	0.750	0.750	1.250	1.344	1 x 1/4-20
16LF050X1/2	16	6F	1.910	1.880	2.125	0.500	0.750	1.250	1.437	1 x 1/4-20
16LF050X5/8	16	6F	1.910	1.880	2.125	0.625	0.750	1.250	1.437	1 x 1/4-20
16LF050X3/4	16	6F	1.910	1.880	2.125	0.750	0.750	1.250	1.437	1 x 1/4-20
17LF050X1/2	17	6F	2.029	1.999	2.250	0.500	0.750	1.250	1.437	1 x 1/4-20
17LF050X5/8	17	6F	2.029	1.999	2.250	0.625	0.750	1.250	1.437	1 x 1/4-20
17LF050X3/4	17	6F	2.029	1.999	2.250	0.750	0.750	1.250	1.437	1 x 1/4-20

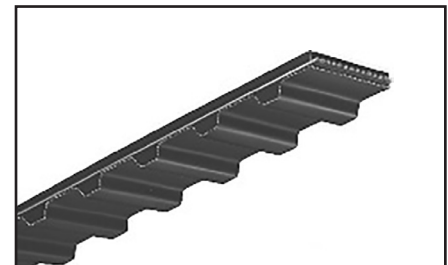
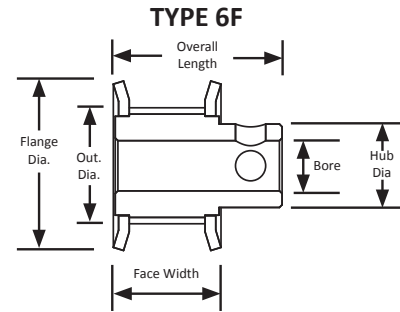

For matching L pitch belts, see page 20 in the MBL Industrial Catalog.

Plain bores, often referred to as minimum plain bores or MPB, are simply untapered bores drilled through the center of a pulley, gear, sprocket, or sheave. Sometimes component part numbers use MPB to designate the plain bore style. Finished bores are plain bores with the addition of either a keyway, set screws, or both. Timing pulleys and roller chain sprockets often use a F in the part number to illustrate a finished bore.

A keyway is a slot cut into a pulley, gear, sprocket, or sheave to accept a key that engages with a similar slot on a shaft to prohibit the relative motion of the two components. Keys connecting shafts to pulley hubs are commonly used to achieve reliable no-slip power transmission in belt drive systems. A set screw is a screw through the pulley, gear, sprocket, or sheave used to tighten the component to the shaft and limit slippage. Typically, set screws are used on larger diameter components as they typically transmit higher loads.

There are some advantages to having a plain bore. With a plain bore, it is easier to customize how the component is affixed to the shaft. A plain bore can be opened to a larger bore diameter, can be made into a finished bore, or can even be customized in other ways such as incorporating pins or screws. There are also advantages to having a finished bore. The most noteworthy advantage is the increased prevention of shaft slippage. It allows for the component to move larger loads with increased accuracy. A noteworthy disadvantage is in the food and beverage industry where set screw holes will at times fill with debris depending on the application.

L TIMING PULLEYS

0.375" Trapezoidal Pitch

For 0.500" Wide Belts

With Flanges

Steel/Iron

Black Oxide Plating

QD® style



Part Number	No. of Teeth	Type	Pitch Dia. (in)	Out. Dia. (in)	Flange Dia. (in)	Bushing	Face Width (in)	Overall Length (in)
QD18L050	18	E1F	2.149	2.119	2.375	JA	0.750	0.750
QD20L050	20	E1F	2.387	2.357	2.625	JA	0.750	0.750
QD22L050	22	E1F	2.626	2.596	2.875	JA	0.750	0.750
QD24L050	24	E1F	2.865	2.835	3.094	SH	0.750	0.750
QD26L050	26	E1F	3.104	3.074	3.33	SH	0.750	0.750
QD28L050	28	E1F	3.342	3.312	3.566	SH	0.750	0.750
QD30L050	30	E1F	3.581	3.551	3.8	SDS	0.750	0.750
QD32L050	32	B1F	3.82	3.79	4.044	SDS	0.750	0.750
QD36L050	36	B1F	4.297	4.267	4.52	SDS	0.750	0.750
QD40L050	40	B1F	4.775	4.745	5.000	SDS	0.750	0.750
QD44L050	44	B1F	5.252	5.222	5.474	SDS	0.750	0.750
QD48L050	48	B1F	5.730	5.700	5.950	SDS	0.750	0.750
QD60L050	60	C3	7.162	7.132	-	SD	0.750	1.250
QD72L050	72	C3	8.594	8.564	-	SD	0.750	1.250
QD84L050	84	C3	10.027	9.997	-	SD	0.750	1.250
QD96L050	96	C3	11.459	11.429	-	SD	0.750	1.250
QD120L050	120	C3	14.324	14.294	-	SD	0.750	1.250

TYPE B1F

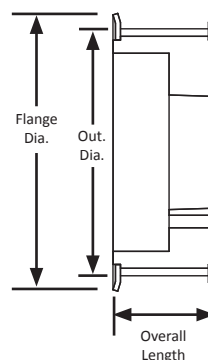

TYPE C3

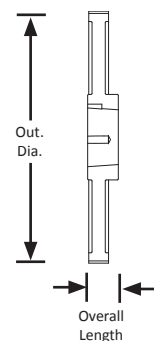

For matching QD® bushings,
see page 89.

TYPE E1F

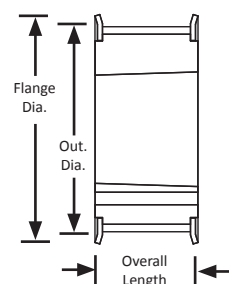

L TIMING PULLEYS

0.375" Trapezoidal Pitch

For 0.500" Wide Belts

Steel/Iron

Black Oxide Plating

Taper-Lock® style



Part Number	No. of Teeth	Type	Pitch Dia. (in)	Out. Dia. (in)	Flange Dia. (in)	Bushing	Face Width (in)	Overall Length (in)
TL18L050-1008	18	8F	2.149	2.119	2.375	1008	0.750	0.875
TL18L050-1108	18	8F	2.149	2.119	2.375	1108	0.750	0.875
TL20L050-1008	20	8F	2.387	2.357	2.625	1008	0.750	0.875
TL20L050-1108	20	8F	2.387	2.357	2.625	1108	0.750	0.875
TL22L050-1008	22	8F	2.626	2.596	2.875	1008	0.750	0.875
TL22L050-1108	22	8F	2.626	2.596	2.875	1108	0.750	0.875
TL24L050	24	8F	2.865	2.835	3.094	1210	0.750	1.000
TL26L050	26	8F	3.104	3.074	3.330	1210	0.750	1.000
TL28L050	28	8F	3.342	3.312	3.566	1210	0.750	1.000
TL30L050	30	8F	3.581	3.551	3.800	1610	0.750	1.000
TL32L050	32	8F	3.820	3.790	4.044	1610	0.750	1.000
TL36L050	36	B1F	4.297	4.267	4.520	1610	0.750	1.000
TL40L050	40	8F	4.775	4.745	4.520	2012	0.750	1.250
TL48L050	48	8F	5.730	5.700	5.950	2012	0.750	1.250
TL60L050	60	7	7.162	7.132	-	2012	0.750	1.250
TL72L050	72	C2	8.594	8.564	-	2012	0.750	1.250
TL84L050	84	C1	10.027	9.997	-	2012	0.750	1.250

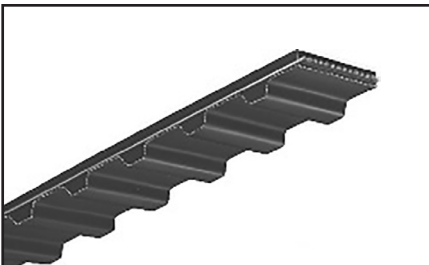
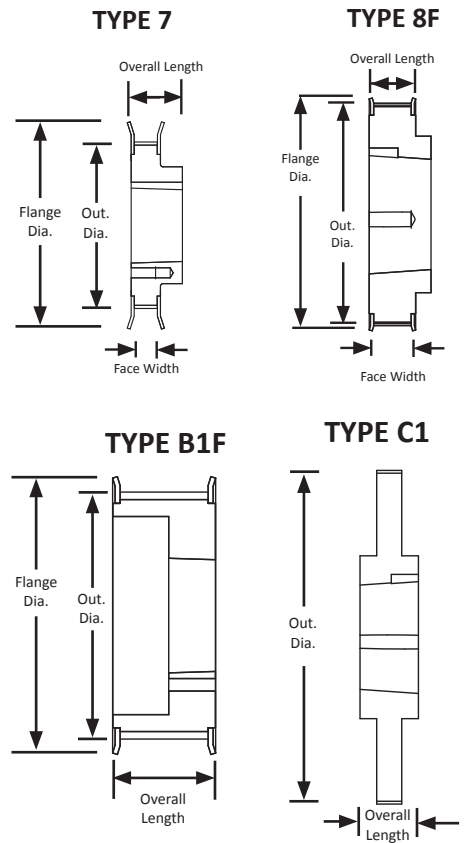

For matching L pitch belts, see page 20 in the MBL Industrial Catalog.



For matching Taper-Lock® bushings, see page 89.

TYPE C2

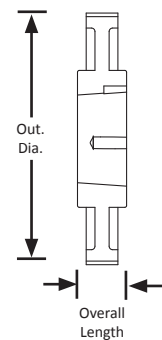

L TIMING PULLEYS

0.375" Trapezoidal Pitch

For 3/4" Wide Belts

Hub and Flanges

Aluminum

Clear Anodized

Finished Bore



Part Number	No. of Teeth	Type	Pitch Dia. (in)	Out. Dia. (in)	Flange Dia. (in)	Bore (in)	Face Width (in)	Overall Length (in)	Hub Dia. (in)	Set Screw
10L075-6FA5	10	6F	1.194	1.164	1.438	0.375	1.000	1.500	0.875	2 x 10-32 @ 90°
12L075-6FA5	12	6F	1.432	1.402	1.656	0.375	1.000	1.500	1.000	2 x 10-32 @ 90°
12L075-6FA6	12	6F	1.432	1.402	1.656	0.500	1.000	1.500	1.000	2 x 1/4-20 @ 90°
12L075-6FA7	12	6F	1.432	1.402	1.656	0.625	1.000	1.500	1.000	2 x 1/4-20 @ 90°
13L075-6FA5	13	6F	1.552	1.522	1.781	0.375	1.000	1.500	1.125	2 x 10-32 @ 90°
14L075-6FA5	14	6F	1.671	1.641	1.906	0.375	1.000	1.500	1.250	2 x 10-32 @ 90°
14L075-6FA6	14	6F	1.671	1.641	1.906	0.500	1.000	1.500	1.250	2 x 1/4-20 @ 90°
14L075-6FA7	14	6F	1.671	1.641	1.906	0.625	1.000	1.500	1.250	2 x 1/4-20 @ 90°
15L075-6FA5	15	6F	1.790	1.760	2.031	0.375	1.000	1.500	1.375	2 x 10-32 @ 90°
15L075-6FA6	15	6F	1.790	1.760	2.031	0.500	1.000	1.500	1.375	2 x 1/4-20 @ 90°
16L075-6FA6	16	6F	1.910	1.880	2.125	0.500	1.000	1.500	1.375	2 x 1/4-20 @ 90°
16L075-6FA7	16	6F	1.910	1.880	2.125	0.625	1.000	1.500	1.375	2 x 1/4-20 @ 90°
17L075-6FA6	17	6F	2.029	1.999	2.250	0.500	1.000	1.500	1.500	2 x 1/4-20 @ 90°
18L075-6FA6	18	6F	2.149	2.119	2.375	0.500	1.000	1.500	1.625	2 x 1/4-20 @ 90°
19L075-6FA6	19	6F	2.268	2.238	2.500	0.500	1.000	1.500	1.687	2 x 1/4-20 @ 90°
20L075-6FA6	20	6F	2.387	2.357	2.625	0.500	1.000	1.500	1.812	2 x 1/4-20 @ 90°
21L075-6FA6	21	6F	2.507	2.477	2.750	0.500	1.000	1.500	2.000	2 x 1/4-20 @ 90°
22L075-6FA6	22	6F	2.626	2.596	2.875	0.500	1.000	1.500	2.125	2 x 1/4-20 @ 90°
24L075-6FA6	24	6F	2.865	2.835	3.094	0.500	1.000	1.500	2.250	2 x 1/4-20 @ 90°
26L075-6FA6	26	6F	3.104	3.074	3.330	0.500	1.000	1.500	2.250	2 x 1/4-20 @ 90°
28L075-6FA6	28	6F	3.342	3.312	3.566	0.500	1.000	1.500	2.250	2 x 1/4-20 @ 90°
30L075-6FA6	30	6F	3.581	3.551	3.800	0.500	1.000	1.500	2.250	2 x 1/4-20 @ 90°
32L075-6FA6	32	6F	3.820	3.790	4.044	0.500	1.000	1.500	2.625	2 x 1/4-20 @ 90°
36L075-6FA6	36	6F	4.297	4.267	4.520	0.500	1.000	1.500	3.500	2 x 1/4-20 @ 90°
40L075-6FA6	40	6F	4.775	4.745	5.000	0.500	1.000	1.500	3.625	2 x 1/4-20 @ 90°

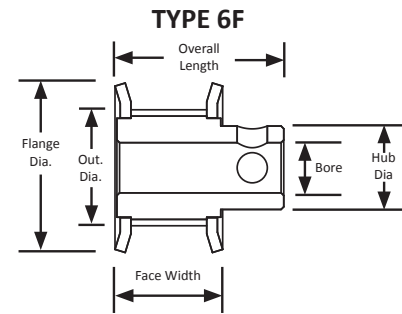

The L pitch is an imperial pitch which is based on the "inch" system of measurement. The imperial pitch tooth profile is a commonly found profile and is trapezoidal in shape. Imperial pitch pulley part numbers can tell you a great deal about the pulley including the number of teeth, pitch, belt width, unit of measure, appearance, material, and bore size.

For more information on part numbers and their meaning, see page 1.

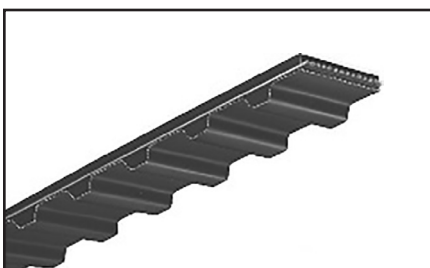

For matching L pitch belts, see page 20 in the MBL Industrial Catalog.

L TIMING PULLEYS

0.375" Trapezoidal Pitch

For 0.750" Wide Belts

Hub and Flanges

Steel/Iron

Black Oxide Plating

Minimum Plain Bore



Part Number	No. of Teeth	Type	Pitch Dia (in)	Out. Dia (in)	Flange Dia. (in)	Bore (in)	Face Width (in)	Overall Length (in)	Hub Dia. (in)
12L075-6FS5	12	6F	1.432	1.402	1.656	0.375	1.000	1.500	1.000
13L075-6FS5	13	6F	1.552	1.522	1.781	0.375	1.000	1.500	1.125
14L075-6FS5	14	6F	1.671	1.641	1.906	0.375	1.000	1.500	1.125
15L075-6FS6	15	6F	1.790	1.760	2.031	0.500	1.000	1.500	1.344
16L075-6FS6	16	6F	1.910	1.880	2.125	0.500	1.000	1.500	1.437
17L075-6FS6	17	6F	2.029	1.999	2.250	0.500	1.000	1.500	1.437
18L075-6FS6	18	6F	2.149	2.119	2.375	0.500	1.000	1.500	1.563
19L075-6FS6	19	6F	2.268	2.238	2.500	0.500	1.000	1.500	1.687
20L075-6FS6	20	6F	2.387	2.357	2.625	0.500	1.000	1.500	1.687
21L075-6FS6	21	6F	2.507	2.477	2.750	0.500	1.000	1.500	2.000
21L075-6FS7	21	6F	2.507	2.477	2.750	0.625	1.000	1.500	2.000
22L075-6FS7	22	6F	2.626	2.596	2.875	0.625	1.000	1.500	2.000
24L075-6FS7	24	6F	2.865	2.835	3.094	0.625	1.000	1.500	2.250
26L075-6FS7	26	6F	3.104	3.074	3.330	0.625	1.000	1.500	2.250
28L075-6FS7	28	6F	3.342	3.312	3.566	0.625	1.000	1.500	2.250
30L075-6FS7	30	6F	3.581	3.551	3.800	0.625	1.000	1.500	2.250
32L075-6FS7	32	6F	3.820	3.790	4.044	0.625	1.000	1.500	2.625
36L075-6FS7	36	6F	4.297	4.267	4.520	0.625	1.000	1.500	3.500
40L075-6FS7	40	6F	4.775	4.745	5.000	0.625	1.000	1.500	3.625

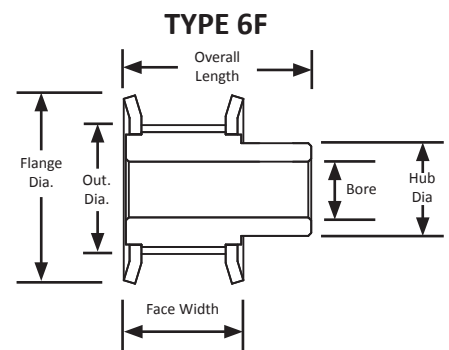

Black Oxide Advantages

Cost Effective

Corrosion Protection

Dimensional Stability

Lubricity

Abrasion Resistance

Decorative Finish

Reduced Light Glare

Pre-treatment for Paint

Conductivity

Surface Property Stability

No Embrittlement

No Welding Fumes

L TIMING PULLEYS

0.375" Trapezoidal Pitch

For 0.750" Wide Belts

Hub and Flanges

Steel

Black Oxide Plating

Finished Bore



Note: Pulleys with bores 0.500" or less have set screws.

Pulleys with bores greater than 0.500" have keyways and set screws.

Part Number	No. of Teeth	Type	Pitch Dia. (in)	Out. Dia. (in)	Flange Dia. (in)	Bore (in)	Face Width (in)	Overall Length (in)	Hub Dia. (in)	Set Screw
12LF075X3/8	12	6F	1.432	1.402	1.656	0.375	1.000	1.500	1.000	1 x 1/4-20
12LF075X1/2	12	6F	1.432	1.402	1.656	0.500	1.000	1.500	1.000	1 x 1/4-20
13LF075X3/8	13	6F	1.552	1.522	1.781	0.375	1.000	1.500	1.125	1 x 1/4-20
13LF075X1/2	13	6F	1.552	1.522	1.781	0.500	1.000	1.500	1.125	1 x 1/4-20
14LF075X3/8	14	6F	1.671	1.641	1.906	0.375	1.000	1.500	1.125	1 x 1/4-20
14LF075X1/2	14	6F	1.671	1.641	1.906	0.500	1.000	1.500	1.125	1 x 1/4-20
15LF075X1/2	15	6F	1.790	1.760	2.031	0.500	1.000	1.500	1.344	1 x 1/4-20
15LF075X5/8	15	6F	1.790	1.760	2.031	0.625	1.000	1.500	1.344	1 x 1/4-20
15LF075X3/4	15	6F	1.790	1.760	2.031	0.750	1.000	1.500	1.344	1 x 1/4-20
16LF075X1/2	16	6F	1.910	1.880	2.125	0.500	1.000	1.500	1.437	1 x 1/4-20
16LF075X5/8	16	6F	1.910	1.880	2.125	0.625	1.000	1.500	1.437	1 x 1/4-20
16LF075X3/4	16	6F	1.910	1.880	2.125	0.750	1.000	1.500	1.437	1 x 1/4-20
17LF075X1/2	17	6F	2.029	1.999	2.250	0.500	1.000	1.500	1.437	1 x 1/4-20
17LF075X5/8	17	6F	2.029	1.999	2.250	0.625	1.000	1.500	1.437	1 x 1/4-20
17LF075X3/4	17	6F	2.029	1.999	2.250	0.750	1.000	1.500	1.437	1 x 1/4-20

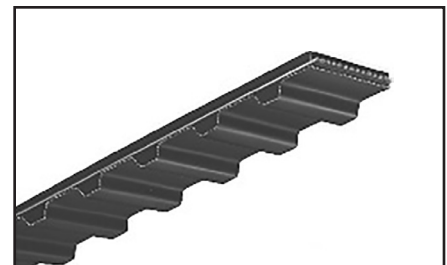
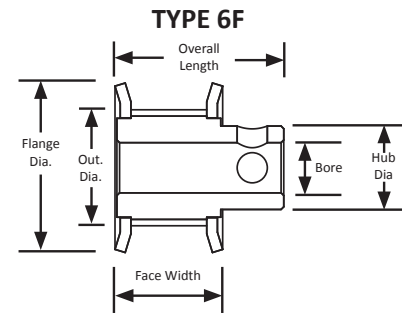

For matching L pitch belts, see page 20 in the MBL Industrial Catalog.

L TIMING PULLEYS

0.375" Trapezoidal Pitch

For 0.750" Wide Belts

Iron

Black Oxide Plating

QD® Style



Part Number	No. of Teeth	Type	Pitch Dia. (in)	Out. Dia. (in)	Flange Dia. (in)	Bushing	Face Width (in)	Overall Length (in)
QD18L075	18	E1F	2.149	2.119	2.375	JA	1.000	1.000
QD20L075	20	E1F	2.387	2.357	2.625	JA	1.000	1.000
QD22L075	22	E1F	2.626	2.596	2.875	JA	1.000	1.000
QD24L075	24	E1F	2.865	2.835	3.094	SH	1.000	1.000
QD26L075	26	E1F	3.104	3.074	3.33	SH	1.000	1.000
QD28L075	28	E1F	3.342	3.312	3.566	SH	1.000	1.000
QD30L075	30	E1F	3.581	3.551	3.8	SDS	1.000	1.000
QD32L075	32	B1F	3.82	3.79	4.044	SDS	1.000	1.000
QD36L075	36	B1F	4.297	4.267	4.52	SDS	1.000	1.000
QD40L075	40	B1F	4.775	4.745	5.000	SDS	1.000	1.000
QD44L075	44	B1F	5.252	5.222	5.474	SDS	1.000	1.000
QD48L075	48	B1F	5.730	5.700	5.950	SDS	1.000	1.000
QD60L075	60	C2	7.162	7.132	-	SD	1.000	1.250
QD72L075	72	C3	8.594	8.564	-	SD	1.000	1.250
QD84L075	84	C3	10.027	9.997	-	SD	1.000	1.250
QD96L075	96	C3	11.459	11.429	-	SD	1.000	1.250
QD120L075	120	C3	14.324	14.294	-	SD	1.000	1.250

TYPE B1F

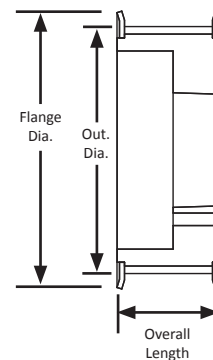

TYPE C2

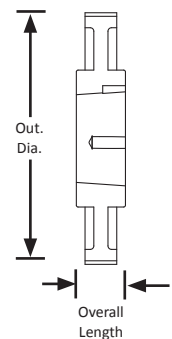

TYPE C3

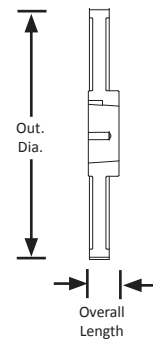

TYPE E1F

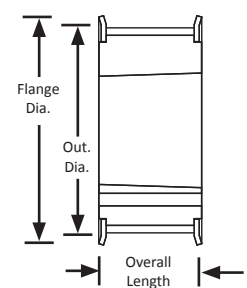

For matching QD® bushings,
see page 89.

L TIMING PULLEYS

0.375" Trapezoidal Pitch

For 0.750" Wide Belts

Steel/Iron

Black Oxide Plating

Taper-Lock® style



Part Number	No. of Teeth	Type	Pitch Dia. (in)	Out. Dia. (in)	Flange Dia. (in)	Bushing	Face Width (in)	Overall Length (in)
TL18L075-1008	18	3F	2.149	2.119	2.375	1008	1.000	1.000
TL18L075-1108	18	3F	2.149	2.119	2.375	1108	1.000	1.000
TL20L075-1008	20	3F	2.387	2.357	2.625	1008	1.000	1.000
TL20L075-1108	20	3F	2.387	2.357	2.625	1108	1.000	1.000
TL22L075-1008	22	3F	2.626	2.596	2.875	1008	1.000	1.000
TL22L075-1108	22	3F	2.626	2.596	2.875	1108	1.000	1.000
TL24L075	24	3F	2.865	2.835	3.094	1210	1.000	1.000
TL26L075	26	3F	3.104	3.074	3.330	1210	1.000	1.000
TL28L075	28	3F	3.342	3.312	3.566	1610	1.000	1.000
TL30L075	30	3F	3.581	3.551	3.800	1610	1.000	1.000
TL32L075	32	3F	3.820	3.790	4.044	1610	1.000	1.000
TL36L075	36	A1F	4.297	4.267	4.520	1610	1.000	1.000
TL40L075	40	8F	4.775	4.745	4.520	2012	1.000	1.250
TL48L075	48	8F	5.730	5.700	5.000	2012	1.000	1.250
TL60L075	60	7	7.162	7.132	-	2012	1.000	1.250
TL72L075	72	C1	8.594	8.564	-	2012	1.000	1.250
TL84L075	84	C1	10.027	9.997	-	2517	1.000	1.750

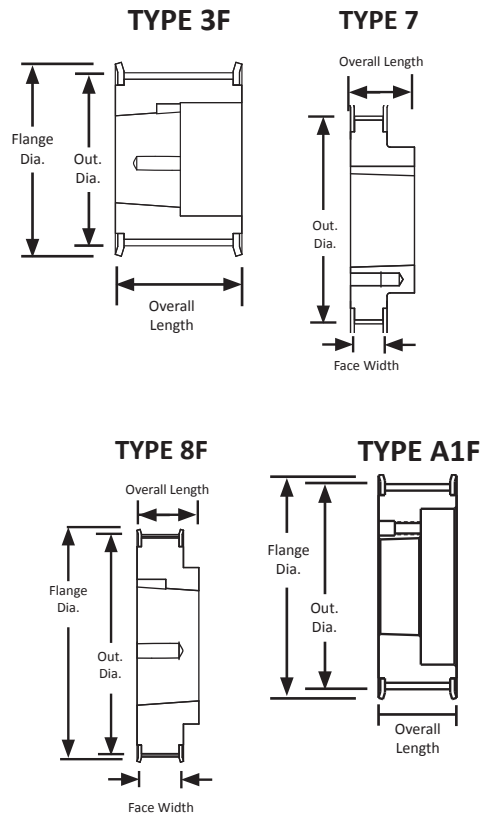

TYPE C1

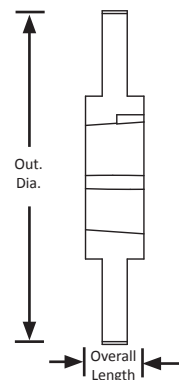

For matching Taper-Lock® bushings, see page 89.

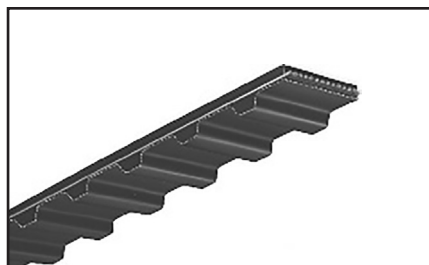

For matching L pitch belts, see page 20 in the MBL Industrial Catalog.

L TIMING PULLEYS

0.375" Trapezoidal Pitch

For 1" Wide Belts

Hub and Flanges

Aluminum

Clear Anodized

Finished Bore



Part Number	No. of Teeth	Type	Pitch Dia. (in)	Out. Dia. (in)	Flange Dia. (in)	Bore (in)	Face Width (in)	Overall Length (in)	Hub Dia. (in)	Set Screw
13L100-6FA5	13	6F	1.552	1.522	1.781	0.375	1.250	1.750	1.125	2 x 10-32 @ 90°
14L100-6FA5	14	6F	1.671	1.641	1.906	0.375	1.250	1.750	1.125	2 x 10-32 @ 90°
15L100-6FA5	15	6F	1.790	1.760	2.031	0.375	1.250	1.750	1.375	2 x 1/4-20 @ 90°
15L100-6FA6	15	6F	1.790	1.760	2.031	0.500	1.250	1.750	1.375	2 x 1/4-20 @ 90°
16L100-6FA6	16	6F	1.910	1.880	2.125	0.500	1.250	1.750	1.375	2 x 1/4-20 @ 90°
17L100-6FA6	17	6F	2.029	1.999	2.250	0.500	1.250	1.750	1.500	2 x 1/4-20 @ 90°
18L100-6FA6	18	6F	2.149	2.119	2.375	0.500	1.250	1.750	1.625	2 x 1/4-20 @ 90°
19L100-6FA6	19	6F	2.268	2.238	2.500	0.500	1.250	1.750	1.687	2 x 1/4-20 @ 90°
20L100-6FA6	20	6F	2.387	2.357	2.625	0.500	1.250	1.750	1.812	2 x 1/4-20 @ 90°
21L100-6FA6	21	6F	2.507	2.477	2.750	0.500	1.250	1.750	2.000	2 x 1/4-20 @ 90°
22L100-6FA6	22	6F	2.626	2.596	2.875	0.500	1.250	1.750	2.125	2 x 1/4-20 @ 90°
24L100-6FA6	24	6F	2.865	2.835	3.094	0.500	1.250	1.750	2.250	2 x 1/4-20 @ 90°
26L100-6FA6	26	6F	3.104	3.074	3.330	0.500	1.250	1.750	2.438	2 x 1/4-20 @ 90°
28L100-6FA6	28	6F	3.342	3.312	3.566	0.500	1.250	1.750	2.688	2 x 1/4-20 @ 90°
30L100-6FA6	30	6F	3.581	3.551	3.800	0.500	1.250	1.750	2.813	2 x 1/4-20 @ 90°
32L100-6FA6	32	6F	3.820	3.790	4.044	0.500	1.250	1.750	3.125	2 x 1/4-20 @ 90°
36L100-6FA6	36	6F	4.297	4.267	4.520	0.500	1.250	1.750	3.500	2 x 1/4-20 @ 90°
40L100-6FA6	40	6F	4.775	4.745	5.000	0.500	1.250	1.750	3.625	2 x 1/4-20 @ 90°

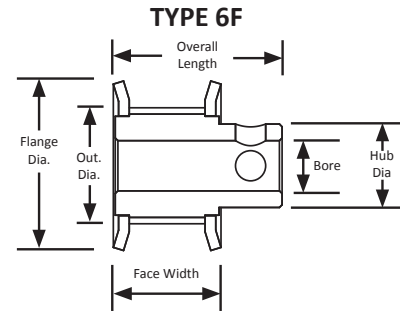

The L pitch is an imperial pitch which is based on the "inch" system of measurement. The imperial pitch tooth profile is a commonly found profile and is trapezoidal in shape. Imperial pitch pulley part numbers can tell you a great deal about the pulley including the number of teeth, pitch, belt width, unit of measure, appearance, material, and bore size.

For more information on part numbers and their meaning, see page 1.

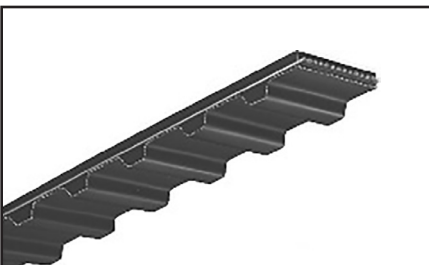

For matching L pitch belts, see page 20 in the MBL Industrial Catalog.

L TIMING PULLEYS

0.375" Trapezoidal Pitch

For 1" Wide Belts

Hub and Flanges

Steel/Iron

Black Oxide Plating

Minimum Plain Bore



Part Number	No. of Teeth	Type	Pitch Dia (in)	Out. Dia (in)	Flange Dia. (in)	Bore (in)	Face Width (in)	Overall Length (in)	Hub Dia. (in)
13L100-6FS5	13	6F	1.552	1.522	1.781	0.375	1.250	1.750	1.125
14L100-6FS5	14	6F	1.671	1.641	1.906	0.375	1.250	1.750	1.125
15L100-6FS6	15	6F	1.790	1.760	2.031	0.500	1.250	1.750	1.344
16L100-6FS6	16	6F	1.910	1.880	2.125	0.500	1.250	1.750	1.437
17L100-6FS6	17	6F	2.029	1.999	2.250	0.500	1.250	1.750	1.437
18L100-6FS6	18	6F	2.149	2.119	2.375	0.500	1.250	1.750	1.563
19L100-6FS6	19	6F	2.268	2.238	2.500	0.500	1.250	1.750	1.687
20L100-6FS6	20	6F	2.387	2.357	2.625	0.500	1.250	1.750	1.687
21L100-6FS7	21	6F	2.507	2.477	2.750	0.625	1.250	1.750	2.000
22L100-6FS7	22	6F	2.626	2.596	2.875	0.625	1.250	1.750	2.000
24L100-6FS7	24	6F	2.865	2.835	3.094	0.625	1.250	1.750	2.250
26L100-6FS7	26	6F	3.104	3.074	3.330	0.625	1.250	1.750	2.250
28L100-6FS7	28	6F	3.342	3.312	3.566	0.625	1.250	1.750	2.250
30L100-6FS7	30	6F	3.581	3.551	3.800	0.625	1.250	1.750	2.250
32L100-6FS7	32	6F	3.820	3.790	4.044	0.625	1.250	1.750	2.625
36L100-6FS7	36	6F	4.297	4.267	4.520	0.625	1.250	1.750	3.500
40L100-6FS7	40	6F	4.775	4.745	5.000	0.625	1.250	1.750	3.625

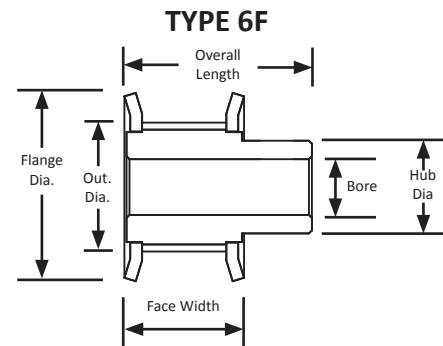

L TIMING PULLEYS

0.375" Trapezoidal Pitch

For 1" Wide Belts

Hub and Flanges

Steel/Iron

Black Oxide Plating

Finished Bore



Note: Pulleys with bores 0.500" or less have set screws.

Pulleys with bores greater than 0.500" have keyways and set screws.

Part Number	No. of Teeth	Type	Pitch Dia. (in)	Out. Dia. (in)	Flange Dia. (in)	Bore (in)	Face Width (in)	Overall Length (in)	Hub Dia. (in)	Set Screw
13LF100X3/8	13	6F	1.552	1.522	1.781	0.375	1.250	1.750	1.125	1 x 1/4-20
13LF100X1/2	13	6F	1.552	1.522	1.781	0.500	1.250	1.750	1.125	1 x 1/4-20
14LF100X3/8	14	6F	1.671	1.641	1.906	0.375	1.250	1.750	1.125	1 x 1/4-20
14LF100X1/2	14	6F	1.671	1.641	1.906	0.500	1.250	1.750	1.125	1 x 1/4-20
15LF100X1/2	15	6F	1.790	1.760	2.031	0.500	1.250	1.750	1.344	1 x 1/4-20
15LF100X5/8	15	6F	1.790	1.760	2.031	0.625	1.250	1.750	1.344	1 x 1/4-20
15LF100X3/4	15	6F	1.790	1.760	2.031	0.750	1.250	1.750	1.344	1 x 1/4-20
16LF100X1/2	16	6F	1.910	1.880	2.125	0.500	1.250	1.750	1.437	1 x 1/4-20
16LF100X5/8	16	6F	1.910	1.880	2.125	0.625	1.250	1.750	1.437	1 x 1/4-20
16LF100X3/4	16	6F	1.910	1.880	2.125	0.750	1.250	1.750	1.437	1 x 1/4-20
17LF100X1/2	17	6F	2.029	1.999	2.250	0.500	1.250	1.750	1.437	1 x 1/4-20
17LF100X5/8	17	6F	2.029	1.999	2.250	0.625	1.250	1.750	1.437	1 x 1/4-20
17LF100X3/4	17	6F	2.029	1.999	2.250	0.750	1.250	1.750	1.437	1 x 1/4-20

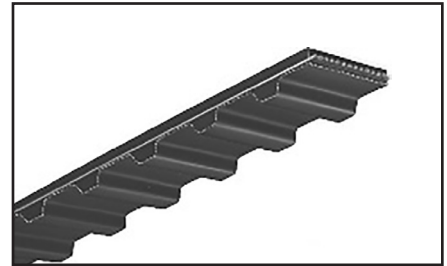
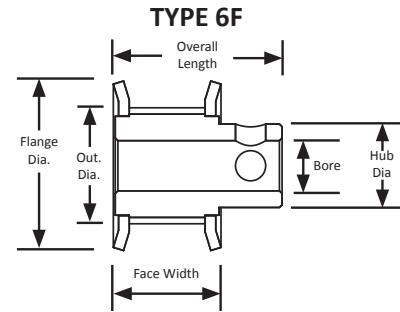

For matching L pitch belts,
see page 20 in the MBL Industrial Catalog.

L TIMING PULLEYS

0.375" Trapezoidal Pitch

For 1" Wide Belts

Flanges

Steel/Iron

Black Oxide Plating

QD® style



Part Number	No. of Teeth	Type	Pitch Dia. (in)	Out. Dia. (in)	Flange Dia. (in)	Bushing	Face Width (in)	Overall Length (in)
QD18L100	18	E1F	2.149	2.119	2.375	JA	1.250	1.250
QD20L100	20	E1F	2.387	2.357	2.625	JA	1.250	1.250
QD22L100	22	E1F	2.626	2.596	2.875	JA	1.250	1.250
QD24L100	24	E1F	2.865	2.835	3.094	SH	1.250	1.250
QD26L100	26	E1F	3.104	3.074	3.33	SH	1.250	1.250
QD28L100	28	E1F	3.342	3.312	3.566	SH	1.250	1.250
QD30L100	30	E1F	3.581	3.551	3.8	SDS	1.250	1.250
QD32L100	32	B1F	3.82	3.79	4.044	SDS	1.250	1.250
QD36L100	36	B1F	4.297	4.267	4.52	SDS	1.250	1.250
QD40L100	40	B1F	4.775	4.745	5.000	SDS	1.250	1.250
QD44L100	44	B1F	5.252	5.222	5.474	SDS	1.250	1.250
QD48L100	48	B1F	5.730	5.700	5.950	SDS	1.250	1.250
QD60L100	60	B2	7.162	7.132	-	SD	1.250	1.250
QD72L100	72	B3	8.594	8.564	-	SD	1.250	1.250
QD84L100	84	B3	10.027	9.997	-	SD	1.250	1.250
QD96L100	96	B3	11.459	11.429	-	SD	1.250	1.250
QD120L100	120	B3	14.324	14.294	-	SD	1.250	1.250

TYPE B1F

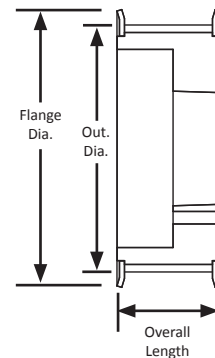

TYPE B2

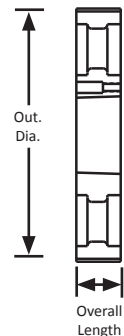

TYPE B3

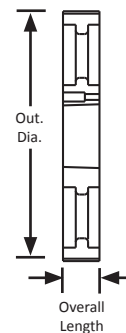

TYPE E1F

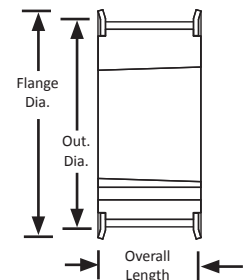

For matching QD® bushings,
see page 89.

L TIMING PULLEYS

0.375" Trapezoidal Pitch

For 1" Wide Belts

Steel/Iron

Black Oxide Plating

Taper-Lock® style



Part Number	No. of Teeth	Type	Pitch Dia. (in)	Out. Dia. (in)	Flange Dia. (in)	Bushing	Face Width (in)	Overall Length (in)
TL18L100-1008	18	3F	2.149	2.119	2.375	1008	1.250	1.250
TL18L100-1108	18	3F	2.149	2.119	2.375	1108	1.250	1.250
TL20L100-1008	20	3F	2.387	2.357	2.625	1008	1.250	1.250
TL20L100-1108	20	3F	2.387	2.357	2.625	1108	1.250	1.250
TL22L100-1008	22	3F	2.626	2.596	2.875	1008	1.250	1.250
TL22L100-1108	22	3F	2.626	2.596	2.875	1108	1.250	1.250
TL24L100	24	3F	2.865	2.835	3.094	1210	1.250	1.250
TL26L100	26	3F	3.104	3.074	3.330	1210	1.250	1.250
TL28L100	28	3F	3.342	3.312	3.566	1610	1.250	1.250
TL30L100	30	3F	3.581	3.551	3.800	1610	1.250	1.250
TL32L100	32	3F	3.820	3.790	4.044	1610	1.250	1.250
TL36L100	36	A1F	4.297	4.267	4.520	1610	1.250	1.250
TL40L100	40	3F	4.775	4.745	4.520	2012	1.250	1.250
TL48L100	48	3F	5.730	5.700	5.000	2012	1.250	1.250
TL60L100	60	3	7.162	7.132	-	2012	1.250	1.250
TL72L100	72	A1	8.594	8.564	-	2012	1.250	1.250
TL84L100	84	C1	10.027	9.997	-	2517	1.250	1.750

TYPE 3

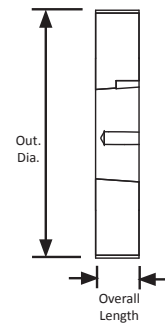

TYPE 3F

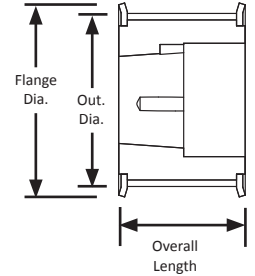

TYPE A1

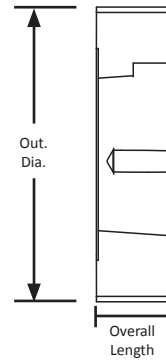

TYPE A1F

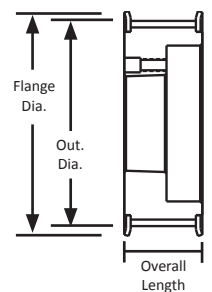

TYPE C1

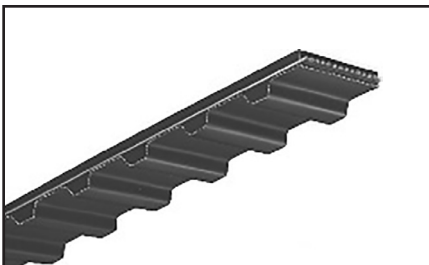
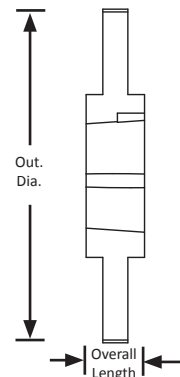

For matching L pitch belts, see page 20 in the MBL Industrial Catalog.



For matching Taper-Lock® bushings, see page 89.

H TIMING PULLEYS

0.500" Trapezoidal Pitch

For 1" Wide Belts

Hub and Flanges

Steel/Iron

Black Oxide Plating

Minimum Plain Bore



Part Number	No. of Teeth	Type	Pitch Dia. (in)	Out. Dia. (in)	Flange Dia. (in)	Bore (in)	Face Width (in)	Overall Length (in)
14H100-6FS7	14	6F	2.228	2.174	2.461	0.625	1.312	1.875
16H100-6FS7	16	6F	2.546	2.492	2.780	0.625	1.312	2.000
17H100-6FS7	17	6F	2.706	2.652	3.000	0.625	1.312	2.000
18H100-6FS7	18	6F	2.865	2.811	3.100	0.625	1.312	2.000
19H100-6FS7	19	6F	3.024	2.970	3.256	0.625	1.312	2.000
20H100-6FS7	20	6F	3.183	3.129	3.420	0.625	1.312	2.125
21H100-6FS8	21	6F	3.342	3.288	3.574	0.750	1.312	2.125
22H100-6FS8	22	6F	3.501	3.447	3.735	0.750	1.312	2.250
24H100-6FS8	24	6F	3.820	3.766	4.050	0.750	1.312	2.250
26H100-6FS8	26	6F	4.138	4.084	4.369	0.750	1.312	2.375
28H100-6FS8	28	6F	4.456	4.402	4.687	0.750	1.312	2.375
30H100-6FS8	30	6F	4.775	4.721	5.005	0.750	1.312	2.375

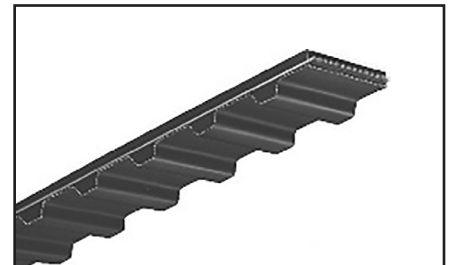
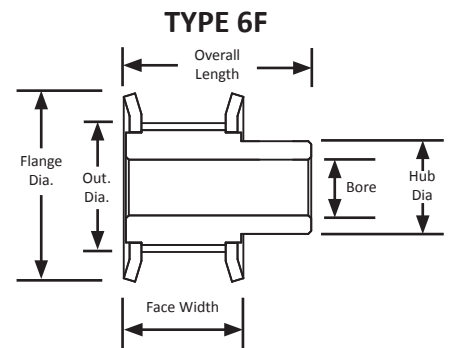

For matching H pitch belts,
see page 20 in the MBL Industrial Catalog.

H TIMING PULLEYS

0.500" Trapezoidal Pitch

For 1" Wide Belts

Steel/Iron

Black Oxide Plating

QD® Style



Part Number	No. of Teeth	Type	Pitch Dia. (in)	Out. Dia. (in)	Flange Dia. (in)	Bushing	Face Width (in)	Overall Length (in)
QD14H100	14	E1F	2.228	2.174	2.461	JA	1.312	1.312
QD16H100	16	E1F	2.546	2.492	2.780	JA	1.312	1.312
QD18H100	18	E1F	2.865	2.811	3.100	SH	1.312	1.312
QD19H100	19	E1F	3.024	2.970	3.256	SH	1.312	1.312
QD20H100	20	E1F	3.183	3.129	3.256	SH	1.312	1.312
QD21H100	21	E1F	3.342	3.288	3.574	SH	1.312	1.312
QD22H100	22	E1F	3.501	3.447	3.735	SDS	1.312	1.312
QD23H100	23	E1F	3.610	3.376	4.050	SDS	1.312	1.312
QD24H100	24	E1F	3.820	3.766	4.050	SDS	1.312	1.312
QD25H100	25	E1F	3.980	3.962	4.369	SDS	1.312	1.312
QD26H100	26	D1F	4.138	4.084	4.369	SDS	1.312	1.312
QD27H100	27	D1F	4.297	4.243	4.687	SDS	1.312	1.312
QD28H100	28	D1F	4.456	4.402	4.687	SDS	1.312	1.312
QD29H100	29	D1F	4.615	4.561	5.000	SD	1.312	1.312
QD30H100	30	B1F	4.775	4.721	5.000	SD	1.312	1.312
QD31H100	31	B1F	4.934	4.880	5.320	SD	1.312	1.312
QD32H100	32	B1F	5.093	5.039	5.320	SK	1.312	1.312

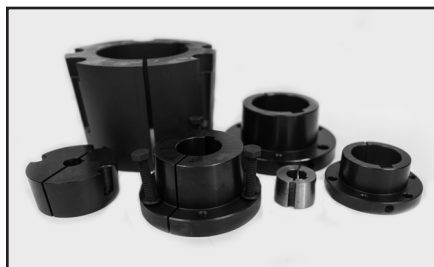
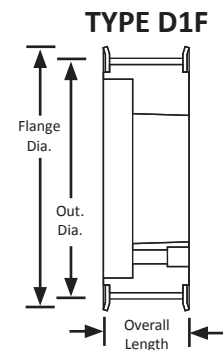
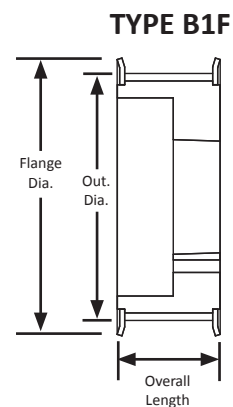

For matching QD® bushings,
see page 89.

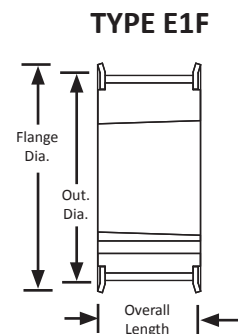

H TIMING PULLEYS

0.500" Trapezoidal Pitch

For 1" Wide Belts

Iron

Black Oxide Plating

QD® Style



Part Number	No. of Teeth	Type	Pitch Dia. (in)	Out. Dia. (in)	Flange Dia. (in)	Bushing	Face Width (in)	Overall Length (in)
QD33H100	33	B1F	5.254	5.198	5.320	SK	1.312	1.312
QD34H100	34	B1F	5.411	5.357	5.959	SK	1.312	1.312
QD35H100	35	B1F	5.573	5.516	5.959	SK	1.312	1.312
QD36H100	36	B1F	5.730	5.676	5.959	SK	1.312	1.312
QD37H100	37	B1F	5.884	5.835	6.375	SK	1.312	1.312
QD38H100	38	B1F	6.048	5.994	6.600	SK	1.312	1.312
QD39H100	39	B1F	6.207	6.153	6.600	SK	1.312	1.312
QD40H100	40	B1F	6.366	6.312	6.600	SK	1.312	1.312
QD41H100	41	B1F	6.525	6.471	6.772	SK	1.312	1.312
QD42H100	42	B1F	6.685	6.631	7.231	SK	1.312	1.312
QD43H100	43	B1F	6.844	6.790	7.231	SK	1.312	1.312
QD44H100	44	B1F	7.003	6.949	7.231	SK	1.312	1.312
QD45H100	45	B1F	7.162	7.108	7.575	SK	1.312	1.312
QD46H100	46	B1F	7.321	7.267	7.575	SK	1.312	1.312
QD48H100	48	B1F	7.639	7.585	7.867	SK	1.312	1.312
QD60H100	60	D3	9.549	9.495	-	SF	1.312	1.312
QD72H100	72	D3	11.459	11.405	-	SF	1.312	1.312
QD84H100	84	D3	13.369	13.315	-	SF	1.312	1.312
QD96H100	96	D3	15.279	15.225	-	SF	1.312	1.312
QD120H100	120	D3	19.099	19.045	-	SF	1.312	1.312
QD156H100	156	D3	24.878	24.774	-	SF	1.312	1.312

TYPE B1F

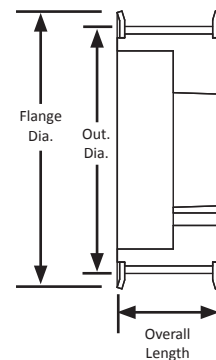

TYPE D3

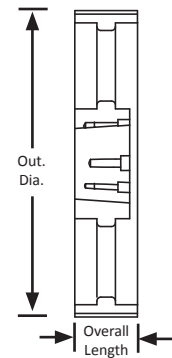

For matching QD® bushings,
see page 89.

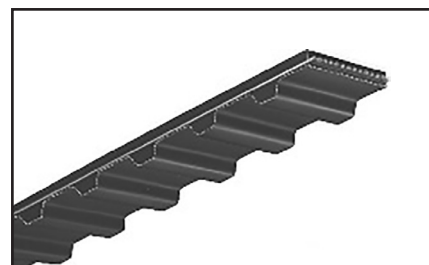

For matching H pitch belts,
see page 20 in the MBL Industrial Catalog.

H TIMING PULLEYS

0.500" Trapezoidal Pitch

For 1" Wide Belts

Steel/Iron

Black Oxide Plating

Taper-Lock® Style



Part Number	No. of Teeth	Type	Pitch Dia. (in)	Out. Dia. (in)	Flange Dia. (in)	Bushing	Face Width (in)	Overall Length (in)
TL14H100-1008	14	A1F	2.228	2.174	2.461	1008	1.312	1.312
TL14H100-1108	14	A1F	2.228	2.174	2.461	1108	1.312	1.312
TL16H100-1008	16	A1F	2.546	2.492	2.780	1008	1.312	1.312
TL16H100-1108	16	A1F	2.546	2.492	2.780	1108	1.312	1.312
TL18H100	18	A1F	2.865	2.811	3.100	1210	1.312	1.312
TL20H100	20	A1F	3.183	3.129	3.256	1210	1.312	1.312
TL22H100	22	A1F	3.501	3.447	3.735	1610	1.312	1.312
TL24H100	24	A1F	3.820	3.766	4.050	1610	1.312	1.312
TL26H100	26	A1F	4.138	4.084	4.369	2012	1.312	1.312
TL28H100	28	A1F	4.456	4.402	4.687	2012	1.312	1.312
TL30H100	30	A1F	4.775	4.721	5.000	2012	1.312	1.312
TL32H100	32	B1F	5.093	5.039	5.320	2517	3.375	3.375
TL40H100	40	B1F	6.366	6.312	6.600	2517	2.344	2.344
TL48H100	48	B1F	7.639	7.585	7.867	2517	1.812	1.812
TL60H100	60	C2	9.549	9.495	-	3020	1.312	2.000
TL72H100	72	C2	11.459	11.405	-	3020	1.312	1.312
TL84H100	84	C3	13.369	13.315	-	3020	1.312	1.312
TL96H100	96	C3	15.279	15.225	-	3020	1.312	1.312
TL120H100	120	C3	19.099	19.045	-	3020	1.312	1.312

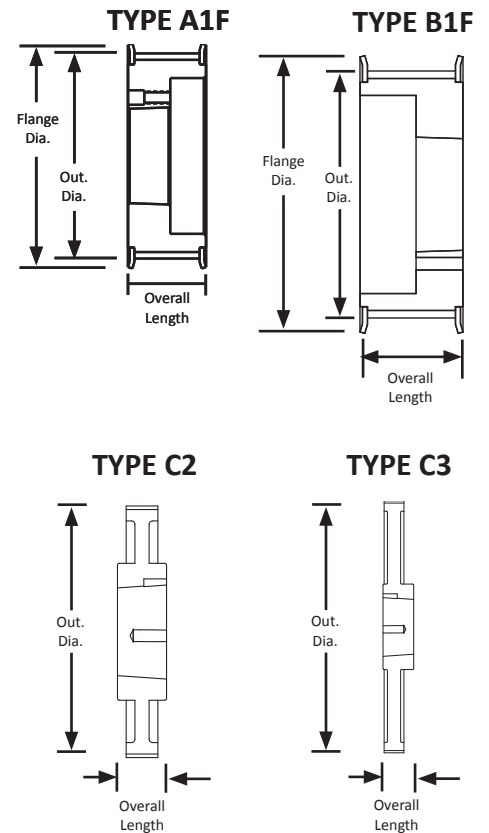

For matching Taper-Lock® bushings, see page 89.

H TIMING PULLEYS

0.500" Trapezoidal Pitch

For 1.5" Wide Belts

Hub and Flanges

Steel/Iron

Black Oxide Plating

Minimum Plain Bore



Part Number	No. of Teeth	Type	Pitch Dia. (in)	Out. Dia. (in)	Flange Dia. (in)	Bore (in)	Face Width (in)	Overall Length (in)
14H150-6FS8	14	6F	2.228	2.174	2.461	0.750	1.812	2.375
16H150-6FS8	16	6F	2.546	2.492	2.780	0.750	1.812	2.500
17H150-6FS8	17	6F	2.706	2.652	3.000	0.750	1.812	2.500
18H150-6FS8	18	6F	2.865	2.811	3.100	0.750	1.812	2.500
19H150-6FS8	19	6F	3.024	2.970	3.256	0.750	1.812	2.500
20H150-6FS8	20	6F	3.183	3.129	3.420	0.750	1.812	2.625
21H150-6FS8	21	6F	3.342	3.288	3.574	0.750	1.812	2.625
22H150-6FS8	22	6F	3.501	3.447	3.735	0.750	1.812	2.750
24H150-6FS8	24	6F	3.820	3.766	4.050	0.750	1.812	2.750
26H150-6FS8	26	6F	4.138	4.084	4.369	0.750	1.812	2.875
28H150-6FS8	28	6F	4.456	4.402	4.687	0.750	1.812	2.875
30H150-6FS8	30	6F	4.775	4.721	5.005	0.750	1.812	2.875

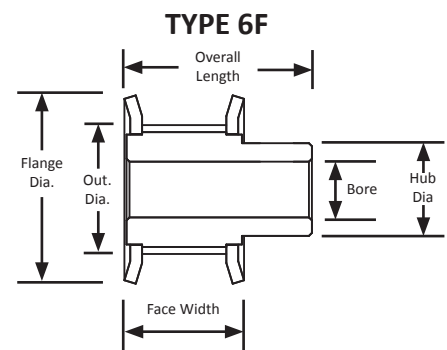

Plain bores, often referred to as minimum plain bores or MPB, are simply untapered bores drilled through the center of a pulley, gear, sprocket, or sheave. Sometimes component part numbers use MPB to designate the plain bore style. Finished bores are plain bores with the addition of either a keyway, set screws, or both. Timing pulleys and roller chain sprockets often use a F in the part number to illustrate a finished bore.

A keyway is a slot cut into a pulley, gear, sprocket, or sheave to accept a key that engages with a similar slot on a shaft to prohibit the relative motion of the two components. Keys connecting shafts to pulley hubs are commonly used to achieve reliable no-slip power transmission in belt drive systems. A set screw is a screw through the pulley, gear, sprocket, or sheave used to tighten the component to the shaft and limit slippage. Typically, set screws are used on larger diameter components as they typically transmit higher loads.

There are some advantages to having a plain bore. With a plain bore, it is easier to customize how the component is affixed to the shaft. A plain bore can be opened to a larger bore diameter, can be made into a finished bore, or can even be customized in other ways such as incorporating pins or screws. There are also advantages to having a finished bore. The most noteworthy advantage is the increased prevention of shaft slippage. It allows for the component to move larger loads with increased accuracy. A noteworthy disadvantage is in the food and beverage industry where set screw holes will at times fill with debris depending on the application.

H TIMING PULLEYS

0.500" Trapezoidal Pitch

For 1.5" Wide Belts

Iron

Black Oxide Plating

QD® Style



Part Number	No. of Teeth	Type	Pitch Dia. (in)	Out. Dia. (in)	Flange Dia. (in)	Bushing	Face Width (in)	Overall Length (in)
QD14H150	14	E1F	2.228	2.174	2.461	JA	1.812	1.812
QD16H150	16	E1F	2.546	2.492	2.780	JA	1.812	1.812
QD18H150	18	E1F	2.865	2.811	3.100	SH	1.812	1.812
QD20H150	20	E1F	3.183	3.129	3.256	SH	1.812	1.812
QD22H150	22	E1F	3.501	3.447	3.735	SD	1.812	1.812
QD24H150	24	E1F	3.820	3.766	4.050	SD	1.812	1.812
QD26H150	26	D1F	4.138	4.084	4.369	SD	1.812	1.812
QD28H150	28	D1F	4.456	4.402	4.687	SD	1.812	1.812
QD30H150	30	B1F	4.775	4.721	5.000	SD	1.812	1.812
QD32H150	32	B1F	5.093	5.039	5.320	SK	1.812	1.812
QD36H150	36	B1F	5.730	5.676	5.959	SK	1.812	1.812
QD40H150	40	B1F	6.366	6.312	6.600	SK	1.812	1.812
QD44H150	44	B1F	7.003	6.949	7.231	SK	1.812	1.812
QD48H150	48	B1F	7.639	7.585	7.867	SK	1.812	1.812
QD60H150	60	D3	9.549	9.495	-	SF	1.812	1.812
QD72H150	72	D2	11.459	11.405	-	SF	1.812	1.812
QD84H150	84	D3	13.369	13.315	-	SF	1.812	1.812
QD96H150	96	D3	15.279	15.225	-	SF	1.812	1.812
QD120H150	120	D3	19.099	19.045	-	SF	1.812	1.812
QD156H150	156	D3	24.828	24.774	-	SF	1.812	1.812

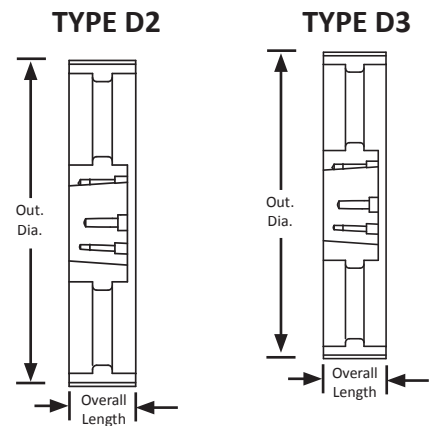
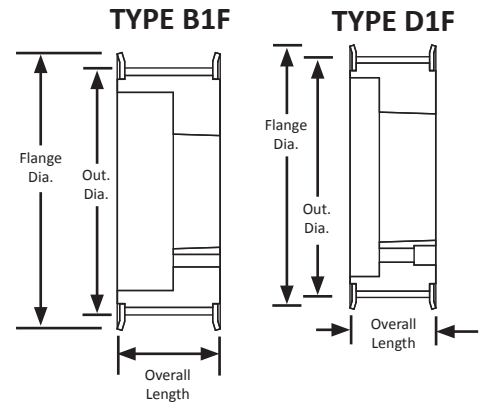

For matching QD® bushings, see page 89.

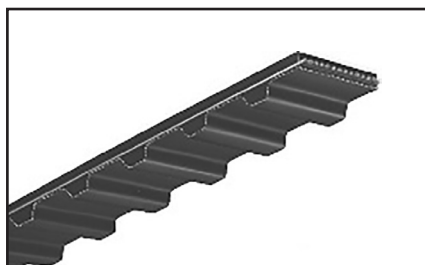

For matching H pitch belts, see page 20 in the MBL Industrial Catalog.

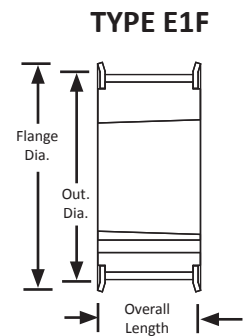

H TIMING PULLEYS

0.500" Trapezoidal Pitch

For 1.5" Wide Belts

Steel/Iron

Black Oxide Plating

Taper-Lock® Style



Part Number	No. of Teeth	Type	Pitch Dia. (in)	Out. Dia. (in)	Flange Dia. (in)	Bushing	Face Width (in)	Overall Length (in)
TL14H150-1008	14	3F	2.228	2.174	2.461	1008	1.812	1.812
TL14H150-1108	14	3F	2.228	2.174	2.461	1108	1.812	1.812
TL16H150	16	3F	2.546	2.492	2.780	1008	1.812	1.812
TL18H150	18	3F	2.865	2.811	3.100	1215	1.812	1.812
TL20H150	20	3F	3.183	3.129	3.256	1215	1.812	1.812
TL22H150	22	3F	3.501	3.447	3.735	1615	1.812	1.812
TL24H150	24	3F	3.820	3.766	4.050	2012	1.812	1.812
TL26H150	26	3F	4.138	4.084	4.369	2012	1.812	1.812
TL28H150	28	3F	4.456	4.402	4.687	2012	1.812	1.812
TL30H150	30	3F	4.775	4.721	5.000	2012	1.812	1.812
TL32H150	32	3F	5.093	5.039	5.320	2517	1.312	1.312
TL40H150	40	3F	6.366	6.312	6.600	2517	3.375	3.375
TL48H150	48	3F	7.639	7.585	7.867	2517	2.344	2.344
TL60H150	60	E2	9.549	9.495	-	3020	1.812	2.000
TL72H150	72	7	11.459	11.405	-	3020	1.812	1.812
TL84H150	84	7	13.369	13.315	-	3020	1.812	1.812
TL96H150	96	C2	15.279	15.225	-	3020	1.812	1.812
TL120H150	120	C2	19.099	19.045	-	3020	1.812	1.812

TYPE 3F

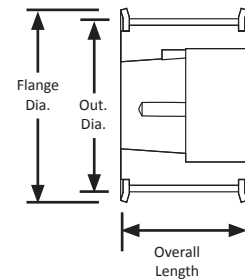

TYPE 7

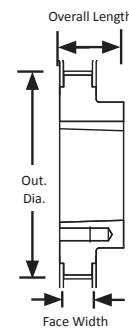

TYPE C2

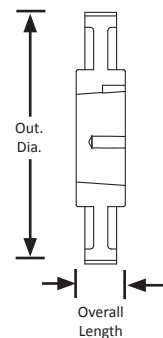

For matching Taper-Lock® bushings, see page 89.

H TIMING PULLEYS

0.500" Trapezoidal Pitch

For 2" Wide Belts

Hub and Flanges

Steel/Iron

Black Oxide Plating

Minimum Plain Bore



Part Number	No. of Teeth	Type	Pitch Dia. (in)	Out. Dia. (in)	Flange Dia. (in)	Bore (in)	Face Width (in)	Overall Length (in)
14H200-6FS8	14	6F	2.228	2.174	2.461	0.750	2.344	2.906
16H200-6FS8	16	6F	2.546	2.492	2.780	0.750	2.344	3.031
17H200-6FS8	17	6F	2.706	2.652	3.000	0.750	2.344	3.031
18H200-6FS8	18	6F	2.865	2.811	3.100	0.750	2.344	3.031
19H200-6FS8	19	6F	3.024	2.970	3.256	0.750	2.344	3.031
20H200-6FS8	20	6F	3.183	3.129	3.420	0.750	2.344	3.156
21H200-6FS10	21	6F	3.342	3.288	3.574	1.000	2.344	3.156
22H200-6FS10	22	6F	3.501	3.447	3.735	1.000	2.344	3.281
24H200-6FS10	24	6F	3.820	3.766	4.050	1.000	2.344	3.281
26H200-6FS10	26	6F	4.138	4.084	4.369	1.000	2.344	3.406
28H200-6FS10	28	6F	4.456	4.402	4.687	1.000	2.344	3.406
30H200-6FS10	30	6F	4.775	4.721	5.005	1.000	2.344	3.406

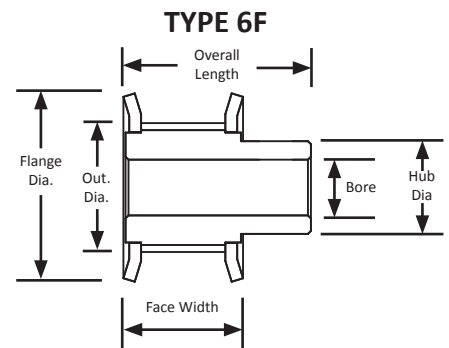

H TIMING PULLEYS

0.500" Trapezoidal Pitch

For 2" Wide Belts

Steel/Iron

Black Oxide Plating

QD® Style



Part Number	No. of Teeth	Type	Pitch Dia. (in)	Out. Dia. (in)	Flange Dia. (in)	Bushing	Face Width (in)	Overall Length (in)
QD14H200	14	E1F	2.228	2.174	2.461	JA	2.344	2.344
QD16H200	16	E1F	2.546	2.492	2.780	JA	2.344	2.344
QD18H200	18	E1F	2.865	2.811	3.100	SH	2.344	2.344
QD20H200	20	E1F	3.183	3.129	3.256	SH	2.344	2.344
QD22H200	22	E1F	3.501	3.447	3.735	SD	2.344	2.344
QD24H200	24	E1F	3.820	3.766	4.050	SD	2.344	2.344
QD26H200	26	D1F	4.138	4.084	4.369	SD	2.344	2.344
QD28H200	28	D1F	4.456	4.402	4.687	SD	2.344	2.344
QD30H200	30	D1F	4.775	4.721	5.000	SD	2.344	2.344
QD32H200	32	B1F	5.093	5.039	5.320	SK	2.344	2.344
QD36H200	36	B1F	5.730	5.676	5.959	SK	2.344	2.344
QD40H200	40	B1F	6.366	6.312	6.600	SK	2.344	2.344
QD44H200	44	B1F	7.003	6.949	7.231	SK	2.344	2.344
QD48H200	48	B1F	7.639	7.585	7.867	SF	2.344	2.344
QD60H200	60	D3	9.549	9.495	-	SF	2.343	2.343
QD72H200	72	D3	11.459	11.405	-	SF	2.343	2.343
QD84H200	84	D3	13.369	13.315	-	SF	2.343	2.343
QD96H200	96	D3	15.279	15.225	-	E	2.343	2.343
QD120H200	120	D3	19.099	19.045	-	E	2.343	2.343
QD156H200	156	D3	24.828	24.774	-	E	2.343	2.343

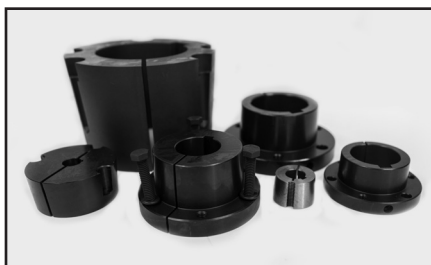
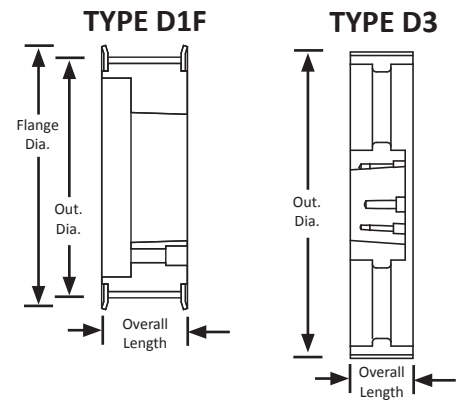
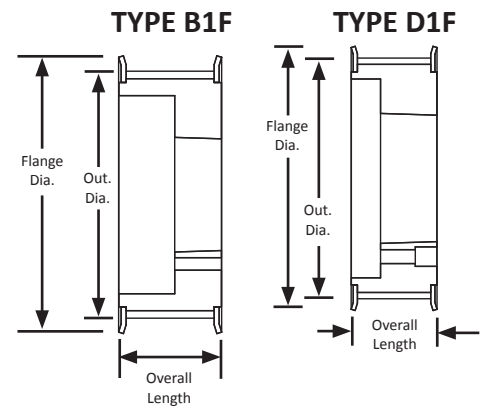

For matching QD® bushings, see page 89.

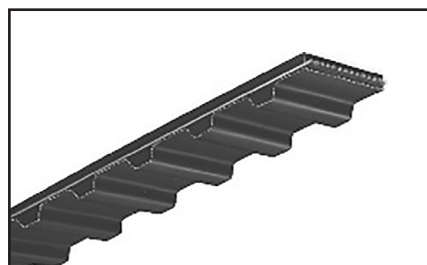

For matching H pitch belts, see page 20 in the MBL Industrial Catalog.

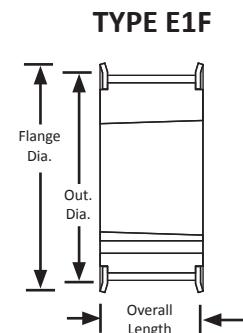

H TIMING PULLEYS

0.500" Trapezoidal Pitch

For 2" Wide Belts

Steel/Iron

Black Oxide Plating

Taper-Lock® Style



Part Number	No. of Teeth	Type	Pitch Dia (in)	Out. Dia (in)	Flange Dia. (in)	Bushing	Face Width (in)	Overall Length (in)
TL16H200	16	3F	2.546	2.492	2.780	1008	2.344	2.344
TL18H200	18	3F	2.865	2.811	3.100	1215	2.344	2.344
TL20H200	20	3F	3.183	3.129	3.256	1215	2.344	2.344
TL22H200	22	3F	3.501	3.447	3.735	1615	2.344	2.344
TL24H200	24	3F	3.820	3.766	4.050	2012	2.344	2.344
TL26H200	26	2F	4.138	4.084	4.369	2012	2.344	2.344
TL28H200	28	2F	4.456	4.402	4.687	2012	2.344	2.344
TL30H200	30	2F	4.775	4.721	5.000	2012	2.344	2.344
TL32H200	32	3F	5.093	5.039	5.320	2517	1.812	1.812
TL40H200	40	3F	6.366	6.312	6.600	2517	1.312	1.312
TL48H200	48	3F	7.639	7.585	7.867	3020	3.375	3.375
TL60H200	60	3	9.549	9.495	-	3020	2.343	2.343
TL72H200	72	3	11.459	11.405	-	3020	2.343	2.343
TL84H200	84	3	13.369	13.315	-	3020	2.343	2.343
TL96H200	96	C2	15.279	15.225	-	3535	2.343	2.343
TL120H200	120	C2	19.099	19.045	-	3020	2.343	2.343

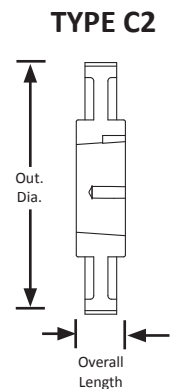
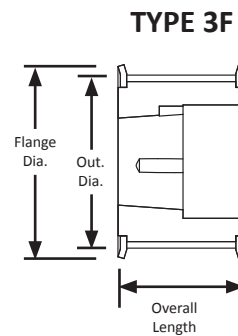
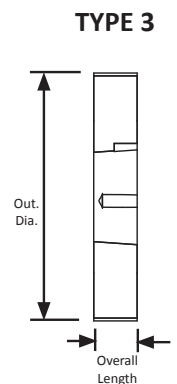
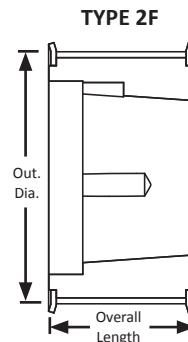

For matching Taper-Lock® bushings, see page 89.

H TIMING PULLEYS

0.500" Trapezoidal Pitch

For 3" Wide Belts

Hub and Flanges

Steel/Iron

Black Oxide Plating

Minimum Plain Bore



Part Number	No. of Teeth	Type	Pitch Dia. (in)	Out. Dia. (in)	Flange Dia. (in)	Bore (in)	Face Width (in)	Overall Length (in)
16H300-6FS8	16	6F	2.546	2.492	2.780	0.750	3.375	4.062
17H300-6FS8	17	6F	2.706	2.652	3.000	0.750	3.375	4.062
18H300-6FS8	18	6F	2.865	2.811	3.100	0.750	3.375	4.062
19H300-6FS8	19	6F	3.024	2.970	3.256	0.750	3.375	4.062
20H300-6FS8	20	6F	3.183	3.129	3.420	0.750	3.375	4.187
21H300-6FS10	21	6F	3.342	3.288	3.574	1.000	3.375	4.187
22H300-6FS11	22	6F	3.501	3.447	3.735	1.125	3.375	4.312
24H300-6FS11	24	6F	3.820	3.766	4.050	1.125	3.375	4.312
26H300-6FS11	26	6F	4.138	4.084	4.369	1.125	3.375	4.437
28H300-6FS11	28	6F	4.456	4.402	4.687	1.125	3.375	4.437
30H300-6FS11	30	6F	4.775	4.721	5.005	1.125	3.375	4.437

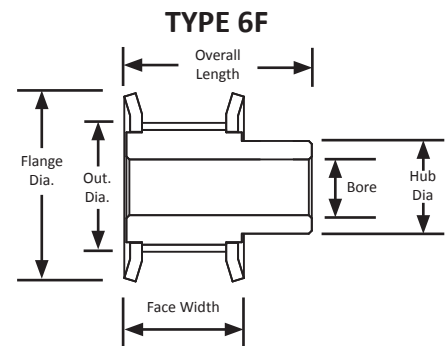

Round-shaped belt teeth enable the distribution of load stress uniformly over the entire belt tooth. Since the belt tooth engages with the pulley groove without any interference, stress concentration at the root of the belt tooth can be eliminated. This belt can be used as an alternative for chain and gears with the added advantages of: High power transmission capacity, long operative life, quiet operation, and cost efficiency.

H TIMING PULLEYS

0.500" Trapezoidal Pitch

For 3" Wide Belts

Iron

Black Oxide Plating

QD® Style



Part Number	No. of Teeth	Type	Pitch Dia. (in)	Out. Dia. (in)	Flange Dia. (in)	Bushing	Face Width (in)	Overall Length (in)
QD22H300	22	E1F	3.501	3.447	3.735	SD	3.375	3.375
QD24H300	24	E1F	3.820	3.766	4.050	SD	3.375	3.375
QD26H300	26	D1F	4.138	4.084	4.369	SD	3.375	3.375
QD28H300	28	D1F	4.456	4.402	4.687	SD	3.375	3.375
QD30H300	30	A1F	4.775	4.721	5.000	SD	3.375	3.375
QD32H300	32	B1F	5.093	5.039	5.320	SK	3.375	3.375
QD36H300	36	B1F	5.730	5.676	5.959	SK	3.375	3.375
QD40H300	40	B1F	6.366	6.312	6.600	SK	3.375	3.375
QD44H300	44	B1F	7.003	6.949	7.231	SK	3.375	3.375
QD48H300	48	B1F	7.639	7.585	7.867	SF	3.375	3.375
QD60H300	60	A3	9.549	9.495	-	SF	3.375	3.375
QD72H300	72	A3	11.459	11.405	-	SF	3.375	3.375
QD84H300	84	A3	13.369	13.315	-	SF	3.375	3.375
QD96H300	96	A3	15.279	15.225	-	E	3.375	3.375
QD120H300	120	A3	19.099	19.045	-	E	3.375	3.375
QD156H300	156	A3	24.828	24.774	-	E	3.375	3.375

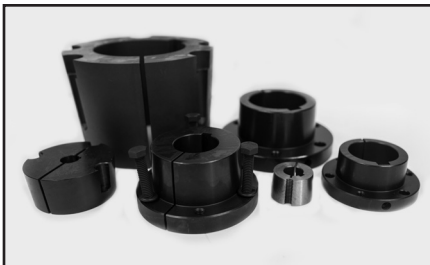
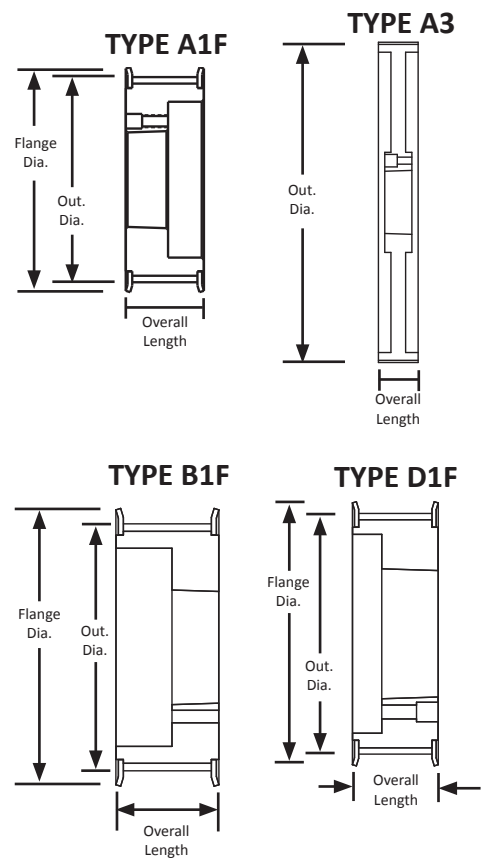

For matching QD® bushings, see page 89.

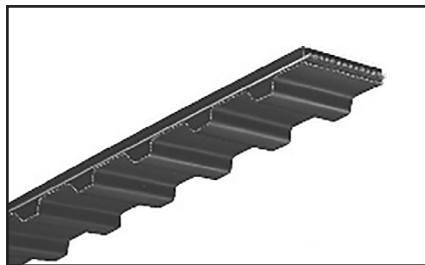

For matching H pitch belts, see page 20 in the MBL Industrial Catalog.

H TIMING PULLEYS

0.500" Trapezoidal Pitch

For 3" Wide Belts

Steel/Iron

Black Oxide Plating

Taper-Lock® Style



Part Number	No. of Teeth	Type	Pitch Dia. (in)	Out. Dia. (in)	Flange Dia. (in)	Bushing	Face Width (in)	Overall Length (in)
TL18H300	18	3F	2.865	2.811	3.100	1215	3.375	3.375
TL20H300	20	3F	3.183	3.129	3.256	1215	3.375	3.375
TL22H300	22	3F	3.501	3.447	3.735	1615	3.375	3.375
TL24H300	24	3F	3.820	3.766	4.050	2012	3.375	3.375
TL26H300	26	2F	4.138	4.084	4.369	2012	3.375	3.375
TL28H300	28	2F	4.456	4.402	4.687	2012	3.375	3.375
TL30H300	30	E1F	4.775	4.721	5.005	2012	3.375	3.375
TL32H300	32	E1F	5.093	5.039	5.320	2517	3.375	3.375
TL40H300	40	E1F	6.366	6.312	6.600	2517	3.375	3.375
TL48H300	48	E1F	7.639	7.585	7.867	3020	3.375	3.375
TL60H300	60	A2	9.549	9.495	-	3020	3.375	3.375
TL72H300	72	A2	11.459	11.405	-	3020	3.375	3.375
TL84H300	84	A3	13.369	13.315	-	3020	3.375	3.375
TL96H300	96	A3	15.279	15.225	-	3535	3.375	3.375
TL120H300	120	A3	19.099	19.045	-	3535	3.375	3.375

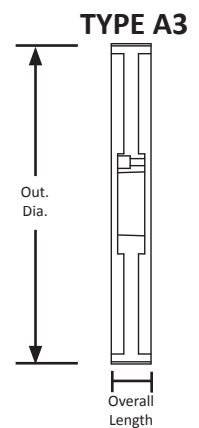
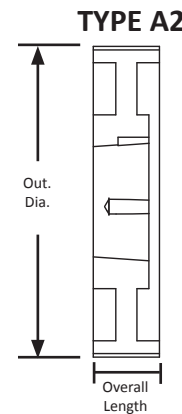
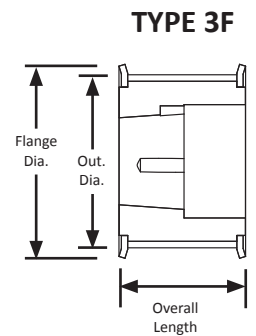
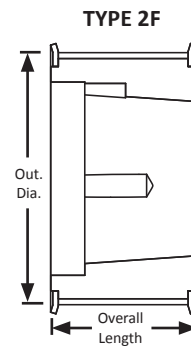

For matching Taper-Lock® bushings, see page 89.

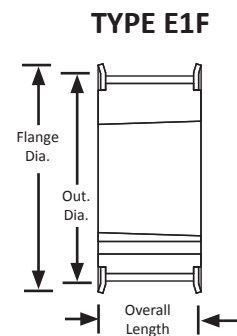

T5 TIMING PULLEYS

METRIC TIMING PULLEY

5 mm Pitch

For 10 mm Wide Belts

Hub

Zinc Plated Steel Flanges

Aluminum

Minimum Plain Bore Style



Part Number	No. of Teeth	Type	Pitch Dia (mm)	Out. Dia. (mm)	Flange Dia (mm)	Bore (mm)	Face Width (mm)	Overall Length (mm)	Hub Dia. (mm)
21T5/10-2	10	6F	16.1	15.1		4.0	15.0	21.0	8.0
21T5/12-2	12	6F	19.3	18.3	23.0	4.0	15.0	21.0	12.0
21T5/14-2	14	6F	22.5	21.5	25.0	4.0	15.0	21.0	14.0
21T5/15-2	15	6F	24.1	23.1	28.0	6.0	15.0	21.0	16.0
21T5/16-2	16	6F	25.6	24.6	32.0	6.0	15.0	21.0	18.0
21T5/18-2	18	6F	28.8	27.8	32.0	6.0	15.0	21.0	20.0
21T5/19-2	19	6F	30.4	29.4	36.0	6.0	15.0	21.0	22.0
21T5/20-2	20	6F	32.0	31.0	36.0	6.0	15.0	21.0	24.0
21T5/22-2	22	6F	35.3	34.3	38.0	6.0	15.0	21.0	25.0
21T5/24-2	24	6F	38.4	37.4	42.0	6.0	15.0	21.0	26.0
21T5/25-2	25	6F	40.0	39.0	44.0	6.0	15.0	21.0	26.0
21T5/26-2	26	6F	41.6	40.6	44.0	6.0	15.0	21.0	26.0
21T5/27-2	27	6F	43.2	42.2	48.0	8.0	15.0	21.0	30.0
21T5/30-2	30	6F	47.8	47.0	51.0	8.0	15.0	21.0	34.0
21T5/32-2	32	6F	50.9	50.1	54.0	8.0	15.0	21.0	38.0
21T5/36-2	36	6F	57.3	56.5	63.0	8.0	15.0	21.0	38.0
21T5/40-2	40	6F	63.7	62.9	66.0	8.0	15.0	21.0	40.0
21T5/48-0	48	6	76.4	75.6	-	8.0	15.0	21.0	50.0
21T5/60-0	60	6	95.5	94.7	-	8.0	15.0	21.0	65.0

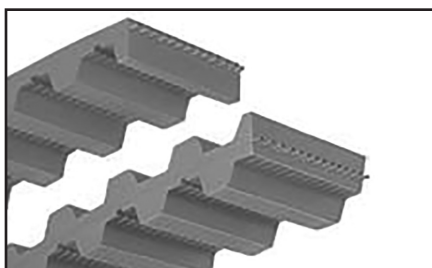
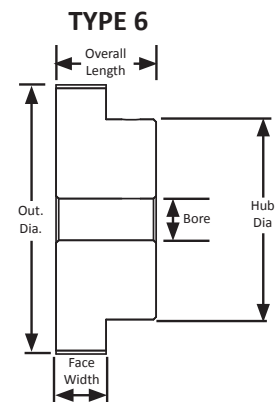
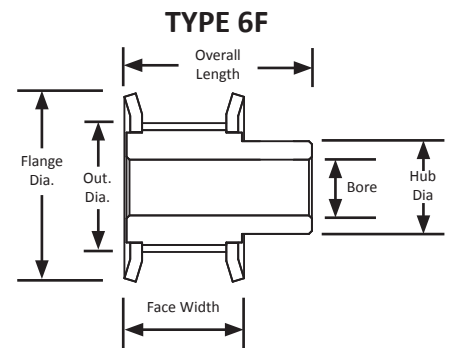

For matching T5 pitch belts, see page 23 or 28 in the MBL Industrial Catalog.

The T5 pitch is a metric pitch tooth profile and is trapezoidal in shape. T5 pitch pulley part numbers can tell you a great deal about the pulley including the number of teeth, pitch, overall length, and number of flanges.

For more information on part numbers and their meaning, see page 1.

T5 TIMING PULLEYS

METRIC TIMING PULLEY

5 mm Pitch

For 16 mm Wide Belts

Hub

Zinc Plated Steel Flanges

Aluminum

Minimum Plain Bore Style



Part Number	No. of Teeth	Type	Pitch Dia. (mm)	Out. Dia. (mm)	Flange Dia. (mm)	Bore (mm)	Face Width (mm)	Overall Length (mm)	Hub Dia. (mm)
27T5/10-2	10	6F	16.1	15.1	19.5	4.0	21.0	27.0	8.0
27T5/12-2	12	6F	19.3	18.3	23.0	4.0	21.0	27.0	12.0
27T5/14-2	14	6F	22.5	21.5	25.0	4.0	21.0	27.0	14.0
27T5/15-2	15	6F	24.1	23.1	28.0	6.0	21.0	27.0	16.0
27T5/16-2	16	6F	25.6	24.6	32.0	6.0	21.0	27.0	18.0
27T5/18-2	18	6F	28.8	27.8	32.0	6.0	21.0	27.0	20.0
27T5/19-2	19	6F	30.4	29.4	36.0	6.0	21.0	27.0	22.0
27T5/20-2	20	6F	32.0	31.0	36.0	6.0	21.0	27.0	24.0
27T5/22-2	22	6F	35.3	34.3	38.0	6.0	21.0	27.0	25.0
27T5/24-2	24	6F	38.4	37.4	42.0	6.0	21.0	27.0	26.0
27T5/25-2	25	6F	40.0	39.0	44.0	6.0	21.0	27.0	26.0
27T5/26-2	26	6F	41.6	40.6	44.0	6.0	21.0	27.0	26.0
27T5/27-2	27	6F	43.2	42.2	48.0	8.0	21.0	27.0	30.0
27T5/30-2	30	6F	48.0	47.0	51.0	8.0	21.0	27.0	34.0
27T5/32-2	32	6F	51.1	50.1	54.0	8.0	21.0	27.0	38.0
27T5/36-2	36	6F	57.5	56.5	63.0	8.0	21.0	27.0	38.0
27T5/40-2	40	6F	63.9	62.9	66.0	8.0	21.0	27.0	40.0
27T5/48-0	48	6	76.6	75.6	-	8.0	21.0	27.0	50.0
27T5/60-0	60	6	95.7	94.7	-	8.0	21.0	27.0	65.0

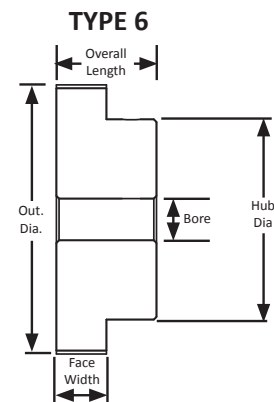
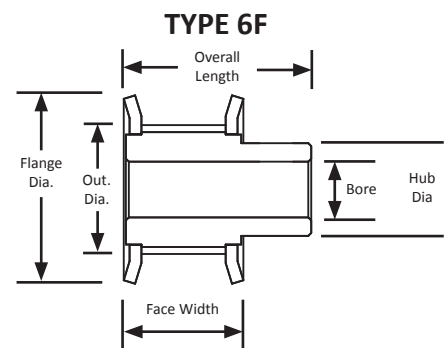

T5 TIMING PULLEYS

METRIC TIMING PULLEY

5 mm Pitch

For 25 mm Wide Belts

Hub

Zinc Plated Steel Flanges

Aluminum

Minimum Plain Bore Style



Part Number	No. of Teeth	Type	Pitch Dia (mm)	Out. Dia. (mm)	Flange Dia (mm)	Bore (mm)	Face Width (mm)	Overall Length (mm)	Hub Dia. (mm)
36T5/10-2	10	6F	16.1	15.1	19.5	6.0	30.0	36.0	8.0
36T5/12-2	12	6F	19.3	18.3	23.0	6.0	30.0	36.0	12.0
36T5/14-2	14	6F	22.5	21.5	25.0	6.0	30.0	36.0	14.0
36T5/15-2	15	6F	24.1	23.1	28.0	6.0	30.0	36.0	16.0
36T5/16-2	16	6F	25.6	24.6	32.0	6.0	30.0	36.0	18.0
36T5/18-2	18	6F	28.8	27.8	32.0	6.0	30.0	36.0	20.0
36T5/19-2	19	6F	30.4	29.4	36.0	6.0	30.0	36.0	22.0
36T5/20-2	20	6F	31.0	31.0	36.0	6.0	30.0	36.0	24.0
36T5/22-2	22	6F	35.3	34.3	38.0	6.0	30.0	36.0	25.0
36T5/24-2	24	6F	38.4	37.4	42.0	6.0	30.0	36.0	26.0
36T5/25-2	25	6F	40.0	39.0	44.0	6.0	30.0	36.0	26.0
36T5/26-2	26	6F	41.6	40.6	44.0	6.0	30.0	36.0	26.0
36T5/27-2	27	6F	43.2	42.2	48.0	8.0	30.0	36.0	30.0
36T5/30-2	30	6F	48.0	47.0	51.0	8.0	30.0	36.0	34.0
36T5/32-2	32	6F	51.1	50.1	54.0	8.0	30.0	36.0	38.0
36T5/36-2	36	6F	57.5	56.5	63.0	8.0	30.0	36.0	38.0
36T5/40-2	40	6F	63.9	62.9	66.0	8.0	30.0	36.0	40.0
36T5/48-0	48	6	76.6	75.6	-	8.0	30.0	36.0	50.0
36T5/60-0	60	6	95.7	94.7	-	8.0	30.0	36.0	65.0

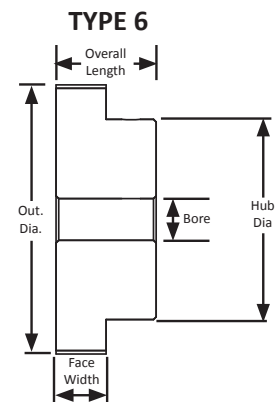
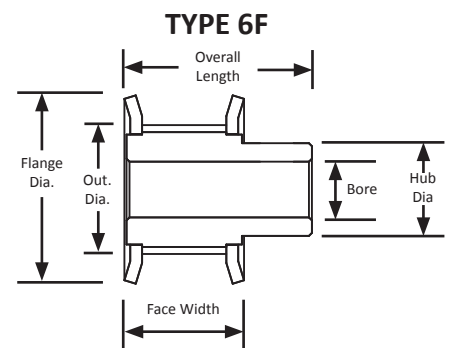

T10 TIMING PULLEYS

METRIC TIMING PULLEY

10 mm Pitch

For 16 mm Wide Belts

Hub

Zinc Plated Steel Flanges

Aluminum

Minimum Plain Bore Style



Part Number	No. of Teeth	Type	Pitch Dia. (mm)	Out. Dia. (mm)	Flange Dia. (mm)	Bore (mm)	Face Width (mm)	Overall Length (mm)	Hub Dia. (mm)
31T10/14-2	14	6F	44.6	42.7	48.0	8.0	21.0	31.0	32.0
31T10/15-2	15	6F	47.8	45.9	51.0	8.0	21.0	31.0	32.0
31T10/16-2	16	6F	50.9	49.1	54.0	8.0	21.0	31.0	35.0
31T10/18-2	18	6F	57.3	55.5	60.0	8.0	21.0	31.0	40.0
31T10/19-2	19	6F	60.5	58.7	66.0	8.0	21.0	31.0	44.0
31T10/20-2	20	6F	63.7	61.8	66.0	8.0	21.0	31.0	46.0
31T10/24-2	24	6F	76.4	74.6	83.0	8.0	21.0	31.0	58.0
31T10/25-2	25	6F	79.6	77.8	83.0	8.0	21.0	31.0	60.0
31T10/27-2	27	6F	86.0	84.1	91.0	8.0	21.0	31.0	60.0
31T10/30-2	30	6F	95.5	93.7	97.0	8.0	21.0	31.0	60.0
31T10/32-2	32	6F	101.9	100.0	106.0	10.0	21.0	31.0	65.0
31T10/36-2	36	6F	114.6	112.8	119.0	10.0	21.0	31.0	70.0
31T10/40-2	40	6F	127.3	125.5	131.0	10.0	21.0	31.0	80.0
31T10/48-0	48	6	152.8	151.0	-	16.0	21.0	31.0	95.0
31T10/60-0	60	6	191.0	189.2	-	16.0	21.0	31.0	110.0

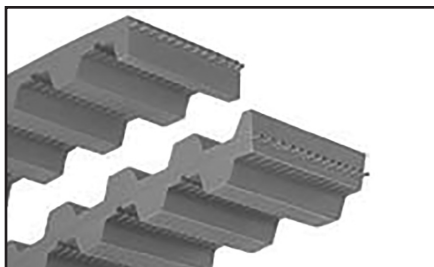
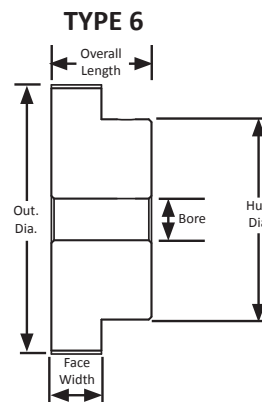
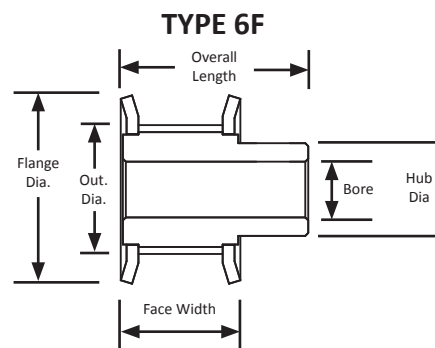

For matching T10 pitch belts, see page 23 or 28 in the MBL Industrial Catalog.

The T10 pitch is a metric pitch tooth profile and is trapezoidal in shape. T10 pitch pulley part numbers can tell you a great deal about the pulley including the number of teeth, pitch, overall length, and number of flanges.

For more information on part numbers and their meaning, see page 1.

T10 TIMING PULLEYS

METRIC TIMING PULLEY

10 mm Pitch

For 25 mm Wide Belts

Hub

Zinc Plated Steel Flanges

Aluminum

Minimum Plain Bore Style



Part Number	No. of Teeth	Type	Pitch Dia (mm)	Out. Dia. (mm)	Flange Dia (mm)	Bore (mm)	Face Width (mm)	Overall Length (mm)	Hub Dia. (mm)
40T10/14-2	14	6F	44.6	42.7	48.0	8.0	30.0	40.0	32.0
40T10/15-2	15	6F	47.8	45.9	51.0	8.0	30.0	40.0	32.0
40T10/16-2	16	6F	50.9	49.1	54.0	8.0	30.0	40.0	35.0
40T10/18-2	18	6F	57.3	55.5	60.0	8.0	30.0	40.0	40.0
40T10/19-2	19	6F	60.5	58.7	66.0	8.0	30.0	40.0	44.0
40T10/20-2	20	6F	63.7	61.8	66.0	8.0	30.0	40.0	46.0
40T10/24-2	24	6F	76.4	74.6	83.0	8.0	30.0	40.0	58.0
40T10/25-2	25	6F	79.6	77.8	83.0	8.0	30.0	40.0	60.0
40T10/27-2	27	6F	86.0	84.1	91.0	8.0	30.0	40.0	60.0
40T10/30-2	30	6F	95.5	93.7	97.0	8.0	30.0	40.0	60.0
40T10/32-2	32	6F	101.9	100.0	106.0	10.0	30.0	40.0	65.0
40T10/36-2	36	6F	114.6	112.8	119.0	10.0	30.0	40.0	70.0
40T10/40-2	40	6F	127.3	125.5	131.0	10.0	30.0	40.0	80.0
40T10/48-0	48	6	152.8	151.0	-	16.0	30.0	40.0	95.0
40T10/60-0	60	6	191.0	189.2	-	16.0	30.0	40.0	110.0

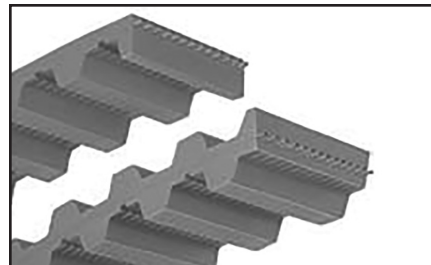
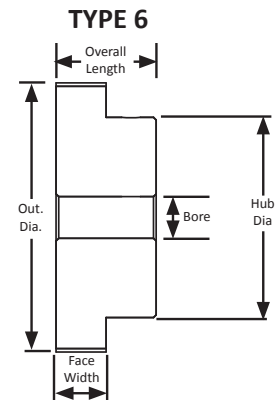
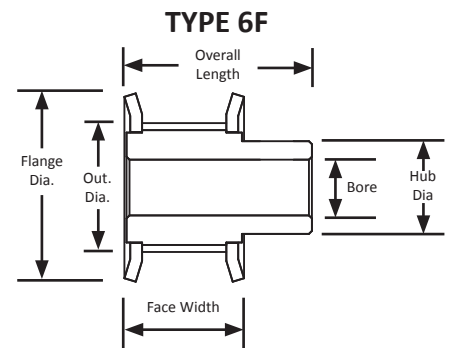

For matching T10 pitch belts, see page 23 or 28 in the MBL Industrial Catalog.

T10 TIMING PULLEYS

METRIC TIMING PULLEY

10 mm Pitch

For 32 mm Wide Belts

Hub

Zinc Plated Steel Flanges

Aluminum

Minimum Plain Bore Style



Part Number	No. of Teeth	Type	Pitch Dia. (mm)	Out. Dia. (mm)	Flange Dia. (mm)	Bore (mm)	Face Width (mm)	Overall Length (mm)	Hub Dia. (mm)
47T10/18-2	18	6F	57.3	55.5	60.0	10.0	37.0	47.0	40.0
47T10/19-2	19	6F	60.5	58.7	66.0	10.0	37.0	47.0	44.0
47T10/20-2	20	6F	63.7	61.8	66.0	12.0	37.0	47.0	46.0
47T10/24-2	24	6F	76.4	74.6	83.0	12.0	37.0	47.0	58.0
47T10/25-2	25	6F	79.6	77.8	83.0	21.0	37.0	47.0	60.0
47T10/27-2	27	6F	86.0	84.1	91.0	12.0	37.0	47.0	60.0
47T10/30-2	30	6F	95.5	93.7	97.0	12.0	37.0	47.0	60.0
47T10/32-2	32	6F	101.9	100.0	106.0	12.0	37.0	47.0	65.0
47T10/36-2	36	6F	114.6	112.8	119.0	16.0	37.0	47.0	70.0
47T10/40-2	40	6F	127.3	125.5	131.0	16.0	37.0	47.0	80.0
47T10/48-0	48	6	152.8	151.0	-	16.0	37.0	47.0	95.0
47T10/60-0	60	6	191.0	189.2	-	16.0	37.0	47.0	110.0

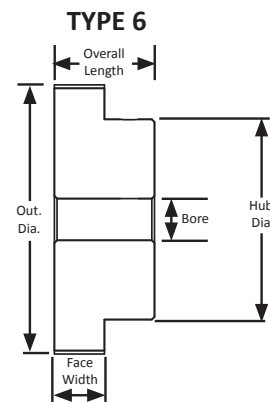
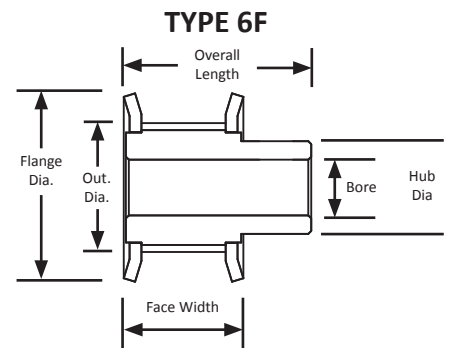

T10 TIMING PULLEYS

METRIC TIMING PULLEY

10 mm Pitch

For 50 mm Wide Belts

Hub

Zinc Plated Steel Flanges

Aluminum

Minimum Plain Bore Style



Part Number	No. of Teeth	Type	Pitch Dia. (mm)	Out. Dia. (mm)	Flange Dia (mm)	Bore (mm)	Face Width (mm)	Overall Length (mm)	Belt Width (mm)	Hub Dia. (mm)
66T10/18-2	18	6F	57.3	55.5	60.0	10.0	56.0	66.0	50.0	40.0
66T10/19-2	19	6F	60.5	58.7	66.0	10.0	56.0	66.0	50.0	44.0
66T10/20-2	20	6F	63.7	61.8	66.0	12.0	56.0	66.0	50.0	46.0
66T10/24-2	24	6F	76.4	74.6	83.0	12.0	56.0	66.0	50.0	58.0
66T10/25-2	25	6F	79.6	77.8	83.0	12.0	56.0	66.0	50.0	60.0
66T10/27-2	27	6F	86.0	84.1	91.0	12.0	56.0	66.0	50.0	60.0
66T10/30-2	30	6F	95.5	93.7	97.0	12.0	56.0	66.0	50.0	60.0
66T10/32-2	32	6F	101.9	100.0	106.0	12.0	56.0	66.0	50.0	65.0
66T10/36-2	36	6F	114.6	112.8	119.0	16.0	56.0	66.0	50.0	70.0
66T10/40-2	40	6F	127.3	125.5	131.0	16.0	56.0	66.0	50.0	80.0
66T10/48-0	48	6	152.8	151.0	-	16.0	56.0	66.0	50.0	95.0
66T10/60-0	60	6	191.0	189.2	-	16.0	56.0	66.0	50.0	110.0

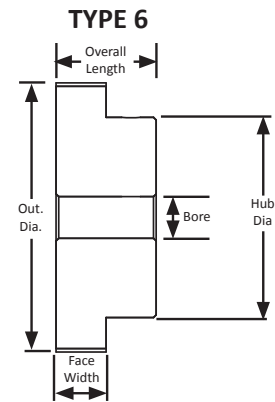
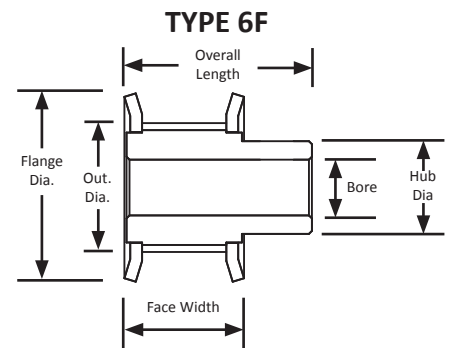

AT5 TIMING PULLEYS

METRIC TIMING PULLEY

5 mm Pitch

For 10 mm Wide Belts

Hub

Zinc Plated Steel Flanges

Aluminum

Minimum Plain Bore Style



Part Number	No. of Teeth	Type	Pitch Dia (mm)	Out. Dia. (mm)	Flange Dia (mm)	Bore (mm)	Face Width (mm)	Overall Length (mm)	Hub Dia. (mm)
21AT5/12-2	12	6F	19.1	17.9	23.0	-	15.0	21.0	12.0
21AT5/14-2	14	6F	22.3	21.1	25.0	-	15.0	21.0	14.0
21AT5/15-2	15	6F	23.9	22.7	28.0	6.0	15.0	21.0	16.0
21AT5/16-2	16	6F	25.5	24.2	32.0	6.0	15.0	21.0	18.0
21AT5/18-2	18	6F	28.7	27.4	32.0	6.0	15.0	21.0	20.0
21AT5/20-2	20	6F	31.8	30.6	36.0	6.0	15.0	21.0	24.0
21AT5/22-2	22	6F	35.0	33.9	38.0	6.0	15.0	21.0	25.0
21AT5/24-2	24	6F	38.2	37.0	42.0	6.0	15.0	21.0	26.0
21AT5/25-2	25	6F	39.8	38.6	44.0	6.0	15.0	21.0	26.0
21AT5/26-2	26	6F	41.4	40.2	44.0	6.0	15.0	21.0	26.0
21AT5/27-2	27	6F	43.0	41.8	48.0	8.0	15.0	21.0	30.0
21AT5/30-2	30	6F	47.8	46.6	51.0	8.0	15.0	21.0	34.0
21AT5/32-2	32	6F	50.9	49.7	54.0	8.0	15.0	21.0	38.0
21AT5/36-2	36	6F	57.3	56.1	63.0	8.0	15.0	21.0	38.0
21AT5/40-2	40	6F	63.7	62.5	66.0	8.0	15.0	21.0	40.0
21AT5/44-0	44	6	70.0	68.8	-	8.0	15.0	21.0	50.0
21AT5/48-0	48	6	76.4	75.2	-	8.0	15.0	21.0	50.0
21AT5/60-0	60	6	95.5	94.3	-	8.0	15.0	21.0	65.0

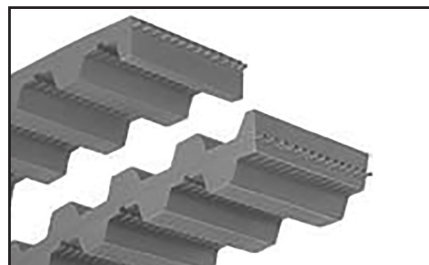
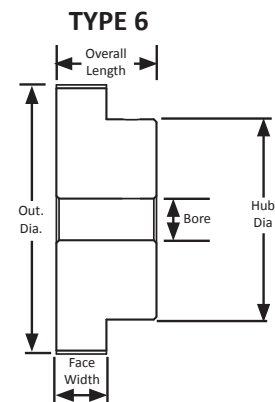
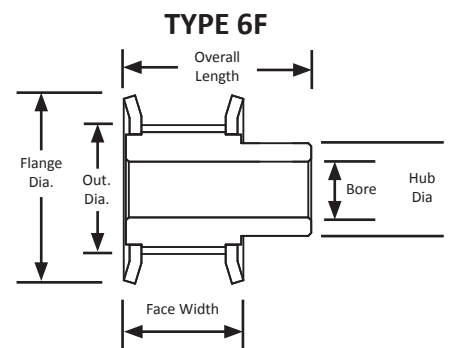

For matching AT5 pitch belts, see page 23 or 28 in the MBL Industrial Catalog.

AT5 TIMING PULLEYS

5 mm Pitch

For 16 mm Wide Belts

Hub

Zinc Plated Steel Flanges

Aluminum

Minimum Plain Bore Style



Part Number	No. of Teeth	Type	Pitch Dia. (mm)	Out. Dia. (mm)	Flange Dia. (mm)	Bore (mm)	Face Width (mm)	Overall Length (mm)	Hub Dia. (mm)
27AT5/12-2	12	6F	19.1	17.9	23.0	-	21.0	27.0	12.0
27AT5/14-2	14	6F	22.3	21.0	25.0	-	21.0	27.0	14.0
27AT5/15-2	15	6F	23.9	22.7	28.0	6.0	21.0	27.0	16.0
27AT5/16-2	16	6F	25.5	24.2	32.0	6.0	21.0	27.0	18.0
27AT5/18-2	18	6F	28.7	27.4	32.0	6.0	21.0	27.0	20.0
27AT5/20-2	20	6F	31.8	30.6	36.0	6.0	21.0	27.0	24.0
27AT5/22-2	22	6F	35.0	33.9	38.0	6.0	21.0	27.0	25.0
27AT5/24-2	24	6F	38.2	37.0	42.0	6.0	21.0	27.0	26.0
27AT5/25-2	25	6F	39.8	38.6	44.0	6.0	21.0	27.0	26.0
27AT5/26-2	26	6F	41.4	40.2	44.0	6.0	21.0	27.0	26.0
27AT5/27-2	27	6F	43.0	41.8	48.0	8.0	21.0	27.0	30.0
27AT5/30-2	30	6F	47.8	46.6	51.0	8.0	21.0	27.0	34.0
27AT5/32-2	32	6F	50.9	49.7	54.0	8.0	21.0	27.0	38.0
27AT5/36-2	36	6F	57.3	56.0	63.0	8.0	21.0	27.0	38.0
27AT5/40-2	40	6F	63.7	62.5	66.0	8.0	21.0	27.0	40.0
27AT5/44-0	44	6	70.0	68.8	-	8.0	21.0	27.0	50.0
27AT5/48-0	48	6	76.4	75.2	-	8.0	21.0	27.0	50.0
27AT5/60-0	60	6	95.5	94.3	-	8.0	21.0	27.0	65.0

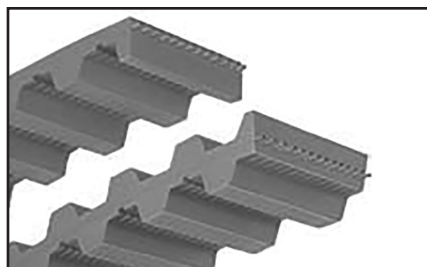
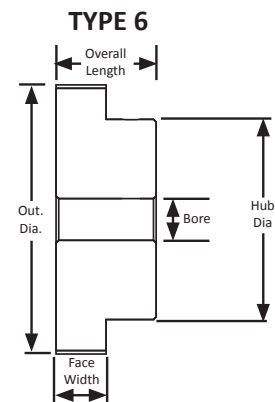
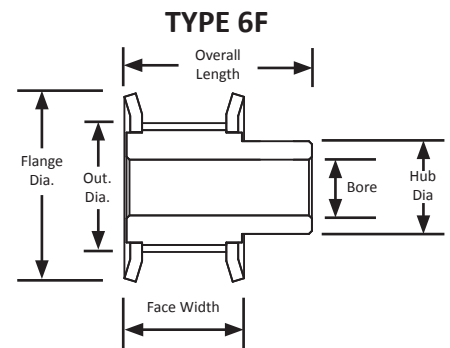

For matching AT5 pitch belts, see page 23 or 28 in the MBL Industrial Catalog.

AT5 TIMING PULLEYS

5 mm Pitch

For 25 mm Wide Belts

Hub

Zinc Plated Steel Flanges

Aluminum

Minimum Plain Bore Style



Part Number	No. of Teeth	Type	Pitch Dia (mm)	Out. Dia. (mm)	Flange Dia (mm)	Bore (mm)	Face Width (mm)	Overall Length (mm)	Hub Dia. (mm)
38AT5/12-2	12	6F	19.1	17.9	23.0	-	32.0	38.0	12.0
38AT5/14-2	14	6F	22.3	21.1	25.0	-	32.0	38.0	14.0
38AT5/15-2	15	6F	23.9	22.7	28.0	6.0	32.0	38.0	16.0
38AT5/16-2	16	6F	25.5	24.2	32.0	6.0	32.0	38.0	18.0
38AT5/18-2	18	6F	28.7	27.4	32.0	6.0	32.0	38.0	20.0
38AT5/20-2	20	6F	31.8	30.6	36.0	6.0	32.0	38.0	24.0
38AT5/22-2	22	6F	35.0	33.9	38.0	6.0	32.0	38.0	25.0
38AT5/24-2	24	6F	38.2	37.0	42.0	8.0	32.0	38.0	26.0
38AT5/25-2	25	6F	39.8	38.6	44.0	8.0	32.0	38.0	26.0
38AT5/26-2	26	6F	41.4	40.2	44.0	8.0	32.0	38.0	26.0
38AT5/27-2	27	6F	43.0	41.8	48.0	8.0	32.0	38.0	30.0
38AT5/30-2	30	6F	47.8	46.6	51.0	8.0	32.0	38.0	34.0
38AT5/32-2	32	6F	50.9	49.7	54.0	8.0	32.0	38.0	38.0
38AT5/36-2	36	6F	57.3	56.1	63.0	8.0	32.0	38.0	38.0
38AT5/40-2	40	6F	63.7	62.5	66.0	8.0	32.0	38.0	40.0
38AT5/44-0	44	6	70.0	68.8	-	8.0	32.0	38.0	50.0
38AT5/48-0	48	6	76.4	75.2	-	8.0	32.0	38.0	50.0
38AT5/60-0	60	6	95.5	94.3	-	8.0	32.0	38.0	65.0
38AT5/72-0	72	6	114.6	113.4	-	10.0	32.0	38.0	80.0

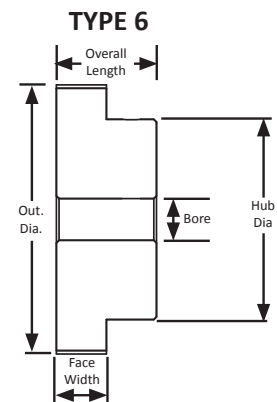
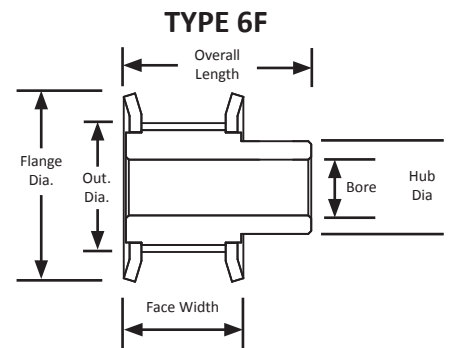

AT10 TIMING PULLEYS

METRIC TIMING PULLEY

10 mm Pitch

For 16 mm Wide Belts

Hub

Zinc Plated Steel Flanges

Aluminum

Minimum Plain Bore Style



Part Number	No. of Teeth	Type	Pitch Dia. (mm)	Out. Dia. (mm)	Flange Dia. (mm)	Bore (mm)	Face Width (mm)	Overall Length (mm)	Hub Dia. (mm)
31AT10/18-2	18	6F	57.3	55.5	60.0	10.0	22.0	31.0	40.0
31AT10/20-2	20	6F	63.7	61.8	66.0	12.0	22.0	31.0	46.0
31AT10/22-2	22	6F	70.0	68.2	66.0	12.0	22.0	31.0	50.0
31AT10/24-2	24	6F	76.4	74.6	83.0	12.0	22.0	31.0	58.0
31AT10/25-2	25	6F	79.6	77.8	83.0	12.0	22.0	31.0	60.0
31AT10/27-2	27	6F	86.0	84.1	91.0	12.0	22.0	31.0	60.0
31AT10/30-2	30	6F	95.5	93.7	97.0	12.0	22.0	31.0	60.0
31AT10/32-2	32	6F	101.9	100.0	106.0	12.0	22.0	31.0	65.0
31AT10/36-2	36	6F	114.6	112.8	119.0	16.0	22.0	31.0	70.0
31AT10/40-2	40	6F	127.3	125.5	131.0	16.0	22.0	31.0	80.0
31AT10/44-2	44	6F	140.1	138.2		16.0	22.0	31.0	90.0
31AT10/48-0	48	6	152.8	151.0	-	16.0	22.0	31.0	95.0
31AT10/60-0	60	6	191.0	189.1	-	16.0	22.0	31.0	110.0

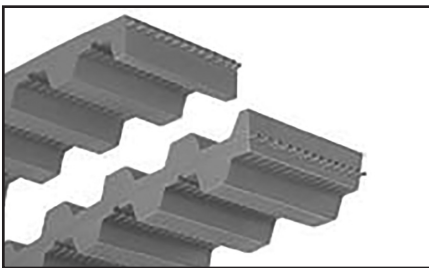
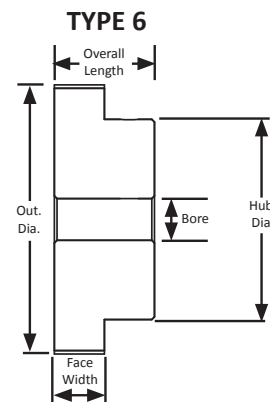
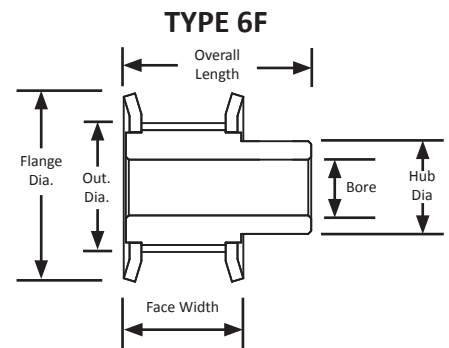

For matching AT10 pitch belts, see page 23 or 28 in the MBL Industrial Catalog.

The AT10 pitch is a metric pitch tooth profile and is trapezoidal in shape. AT10 pitch pulley part numbers can tell you a great deal about the pulley including the number of teeth, pitch, overall length, and number of flanges.

For more information on part numbers and their meaning, see page 1.

AT10 TIMING PULLEYS

METRIC TIMING PULLEY

10 mm Pitch

For 25 mm Wide Belts

Hub

Zinc Plated Steel Flanges

Aluminum

Minimum Plain Bore Style



Part Number	No. of Teeth	Type	Pitch Dia (mm)	Out. Dia. (mm)	Flange Dia (mm)	Bore (mm)	Face Width (mm)	Overall Length (mm)	Hub Dia. (mm)
42AT10/18-2	18	6F	57.3	55.5	60.0	10.0	32.0	42.0	40.0
42AT10/20-2	20	6F	63.7	61.8	66.0	12.0	32.0	42.0	46.0
42AT10/22-2	22	6F	70.0	68.2	66.0	12.0	32.0	42.0	50.0
42AT10/24-2	24	6F	76.4	74.6	83.0	12.0	32.0	42.0	58.0
42AT10/25-2	25	6F	79.6	77.8	83.0	12.0	32.0	42.0	60.0
42AT10/27-2	27	6F	86.0	84.1	91.0	12.0	32.0	42.0	60.0
42AT10/30-2	30	6F	95.5	93.7	97.0	12.0	32.0	42.0	60.0
42AT10/32-2	32	6F	101.9	100.0	106.0	12.0	32.0	42.0	65.0
42AT10/36-2	36	6F	114.6	112.8	119.0	16.0	32.0	42.0	70.0
42AT10/40-2	40	6F	127.3	125.5	131.0	16.0	32.0	42.0	80.0
42AT10/44-2	44	6F	140.1	138.2	144.0	16.0	32.0	42.0	90.0
42AT10/48-0	48	6	152.8	151.0	-	16.0	32.0	42.0	95.0
42AT10/60-0	60	6	191.0	189.1	-	16.0	32.0	42.0	110.0

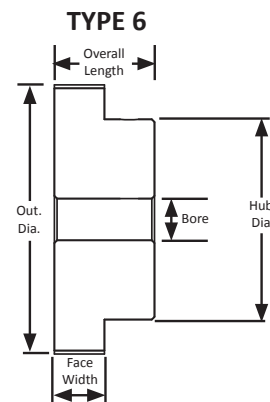
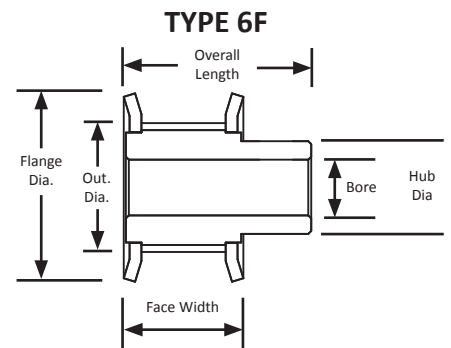

AT10 TIMING PULLEYS

METRIC TIMING PULLEY

10 mm Pitch

For 32 mm Wide Belts

Hub

Zinc Plated Steel Flanges

Aluminum

Minimum Plain Bore Style



Part Number	No. of Teeth	Type	Pitch Dia. (mm)	Out. Dia. (mm)	Flange Dia. (mm)	Bore (mm)	Face Width (mm)	Overall Length (mm)	Hub Dia. (mm)
47AT10/18-2	18	6F	57.3	55.5	60.0	10.0	38.0	47.0	40.0
47AT10/20-2	20	6F	63.7	61.8	66.0	12.0	38.0	47.0	46.0
47AT10/22-2	22	6F	70.0	68.2	66.0	12.0	38.0	47.0	50.0
47AT10/24-2	24	6F	76.4	74.6	83.0	12.0	38.0	47.0	58.0
47AT10/25-2	25	6F	79.6	77.8	83.0	12.0	38.0	47.0	60.0
47AT10/27-2	27	6F	86.0	84.1	91.0	12.0	38.0	47.0	60.0
47AT10/30-2	30	6F	95.5	93.7	97.0	12.0	38.0	47.0	60.0
47AT10/32-2	32	6F	101.9	100.0	106.0	12.0	38.0	47.0	65.0
47AT10/36-2	36	6F	114.6	112.8	119.0	16.0	38.0	47.0	70.0
47AT10/40-2	40	6F	127.3	125.5	131.0	16.0	38.0	47.0	80.0
47AT10/44-2	44	6F	140.1	138.2	-	16.0	38.0	47.0	90.0
47AT10/48-0	48	6	152.8	151.0	-	16.0	38.0	47.0	95.0
47AT10/60-0	60	6	191.0	189.1	-	16.0	38.0	47.0	110.0

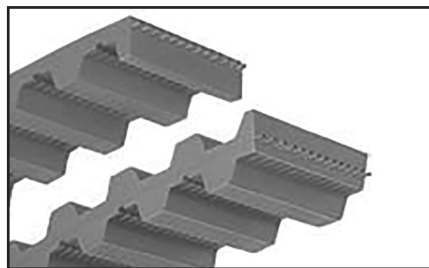
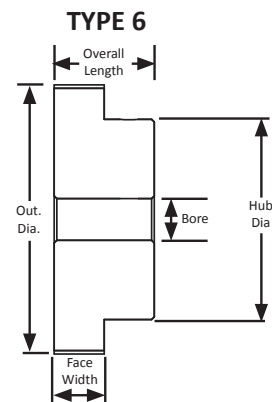
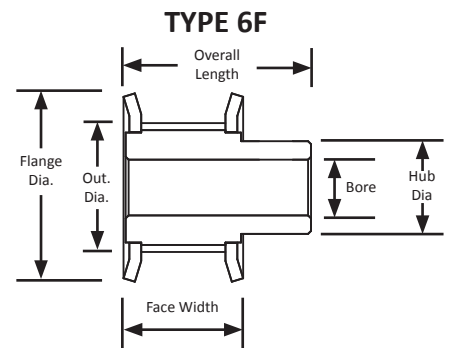

For matching AT10 pitch belts, see page 23 or 28 in the MBL Industrial Catalog.

AT10 TIMING PULLEYS

METRIC TIMING PULLEY

10 mm Pitch

For 50 mm Wide Belts

Hub

Zinc Plated Steel Flanges

Aluminum

Minimum Plain Bore Style



Part Number	No. of Teeth	Type	Pitch Dia (mm)	Out. Dia. (mm)	Flange Dia. (mm)	Bore (mm)	Face Width (mm)	Overall Length (mm)	Hub Dia. (mm)
66AT10/18-2	18	6F	57.3	55.5	60.0	10.0	57.0	66.0	40.0
66AT10/20-2	20	6F	63.7	61.8	66.0	12.0	57.0	66.0	46.0
66AT10/22-2	22	6F	70.0	68.2	66.0	12.0	57.0	66.0	50.0
66AT10/24-2	24	6F	76.4	74.6	83.0	12.0	57.0	66.0	58.0
66AT10/25-2	25	6F	79.6	77.8	83.0	12.0	57.0	66.0	60.0
66AT10/27-2	27	6F	86.0	84.1	91.0	12.0	57.0	66.0	60.0
66AT10/30-2	30	6F	95.5	93.7	97.0	12.0	57.0	66.0	60.0
66AT10/32-2	32	6F	101.9	100.0	106.0	12.0	57.0	66.0	65.0
66AT10/36-2	36	6F	114.6	112.8	119.0	16.0	57.0	66.0	70.0
66AT10/40-2	40	6F	127.3	125.5	131.0	16.0	57.0	66.0	80.0
66AT10/44-2	44	6F	140.1	138.2		16.0	57.0	66.0	90.0
66AT10/48-0	48	6	152.8	151.0	-	16.0	57.0	66.0	95.0
66AT10/60-0	60	6	191.0	189.1	-	16.0	57.0	66.0	110.0

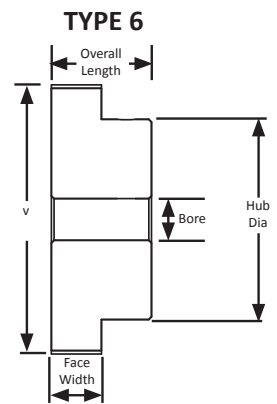
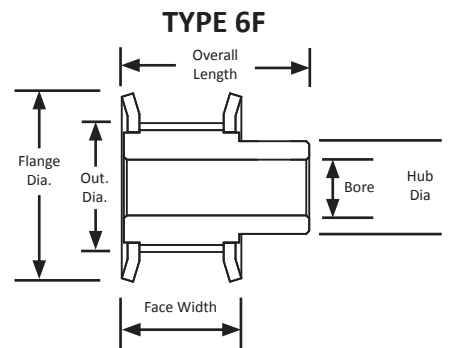

J SECTION RIBSTAR SHEAVES

For 6 Groove J Section Belts
 Finished Bores with Keyway at Less
 than 2.000" OD

QD® Style at 2.000" OD and greater
 Steel

Black Oxide



Part Number	Pitch Diameter (in)	Outside Diameter (in)	Overall Length (in)	Bore/Bushing	Ribs	Set Screw
6J150X1/2	1.530"	1.500"	1.188"	0.500"	6	1 x 5/16-18
6J150X5/8	1.530"	1.500"	1.188"	0.625"	6	1 x 5/16-18
6J150X3/4	1.530"	1.500"	1.188"	0.750"	6	1 x 5/16-18
6J150X1	1.530"	1.500"	1.188"	1.000"	6	1 x 5/16-18
6J160X1/2	1.630"	1.600"	1.188"	0.500"	6	1 x 5/16-18
6J160X5/8	1.630"	1.600"	1.188"	0.625"	6	1 x 5/16-18
6J160X3/4	1.630"	1.600"	1.188"	0.750"	6	1 x 5/16-18
6J170X1/2	1.730"	1.700"	1.188"	0.500"	6	1 x 5/16-18
6J180X1/2	1.830"	1.800"	1.188"	0.500"	6	1 x 5/16-18
6J180X5/8	1.830"	1.800"	1.188"	0.625"	6	1 x 5/16-18
6J180X3/4	1.830"	1.800"	1.188"	0.750"	6	1 x 5/16-18
6J190X1/2	1.930"	1.900"	1.188"	0.500"	6	1 x 5/16-18
6J190X5/8	1.930"	1.900"	1.188"	0.625"	6	1 x 5/16-18
6J190X7/8	1.930"	1.900"	1.188"	0.875"	6	1 x 5/16-18
6J200JA	2.030"	2.000"	-	JA	6	-
6J212JA	2.150"	2.120"	-	JA	6	-
6J224JA	2.270"	2.240"	-	JA	6	-
6J236JA	2.390"	2.360"	-	JA	6	-
6J250JA	2.530"	2.500"	-	JA	6	-
6J265JA	2.680"	2.650"	-	JA	6	-
6J280JA	2.830"	2.800"	-	JA	6	-
6J300JA	3.030"	3.000"	-	JA	6	-
6J315JA	3.180"	3.150"	-	JA	6	-
6J335JA	3.380"	3.350"	-	JA	6	-
6J450SH	4.530"	4.500"	-	SH	6	-
6J600SH	6.030"	6.000"	-	SH	6	-

Finished Bore

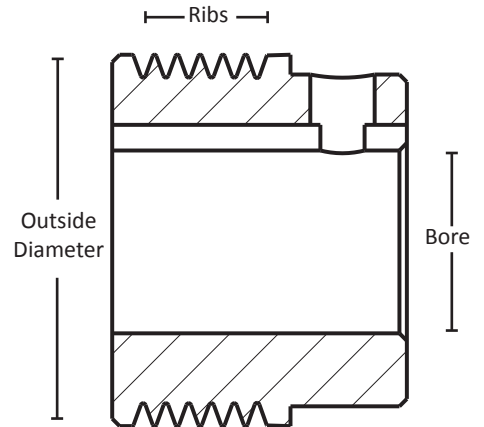

QD® Style

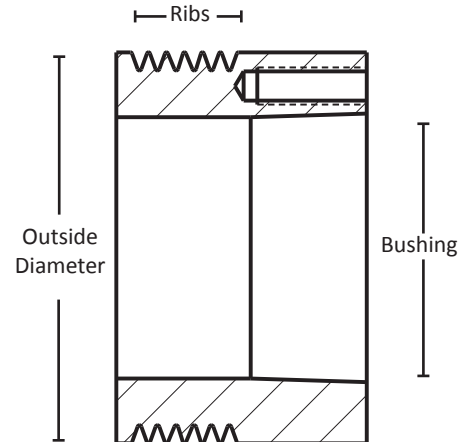

J SECTION RIBSTAR SHEAVES

For 10 Groove J Section Belts

QD® Style

Steel

Black Oxide



Part Number	Pitch Diameter (in)	Outside Diameter (in)	Bushing	Ribs
10J200JA	2.030"	2.000"	JA	10
10J212JA	2.150"	2.120"	JA	10
10J224JA	2.270"	2.240"	JA	10
10J236JA	2.390"	2.360"	JA	10
10J250JA	2.530"	2.500"	JA	10
10J265JA	2.680"	2.650"	JA	10
10J280JA	2.830"	2.800"	JA	10
10J300JA	3.030"	3.000"	JA	10
10J315JA	3.180"	3.150"	JA	10
10J335SH	3.380"	3.350"	SH	10
10J450SH	4.530"	4.500"	SH	10
10J600SH	6.030"	6.000"	SH	10

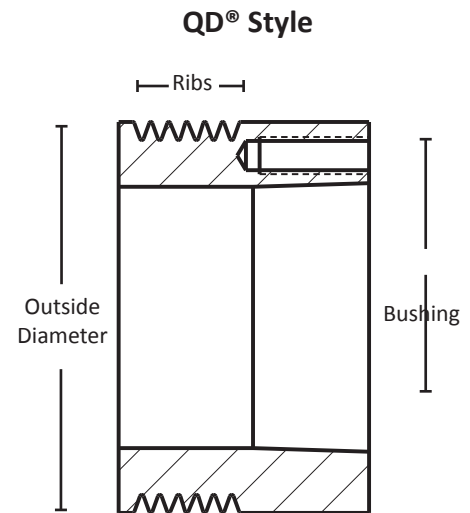

Poly V

J SECTION RIBSTAR SHEAVES

For 16 Groove J Section Belts

QD® Style

Steel

Black Oxide



Part Number	Pitch Diameter (in)	Outside Diameter (in)	Bushing	Ribs
16J250JA	2.530"	2.500"	JA	16
16J265JA	2.680"	2.650"	JA	16
16J280JA	2.830"	2.800"	JA	16
16J300SH	3.030"	3.000"	SH	16
16J315SH	3.180"	3.150"	SH	16
16J335SH	3.380"	3.350"	SH	16
16J450SH	4.530"	4.500"	SH	16
16J600SH	6.030"	6.000"	SH	16

QD® Style

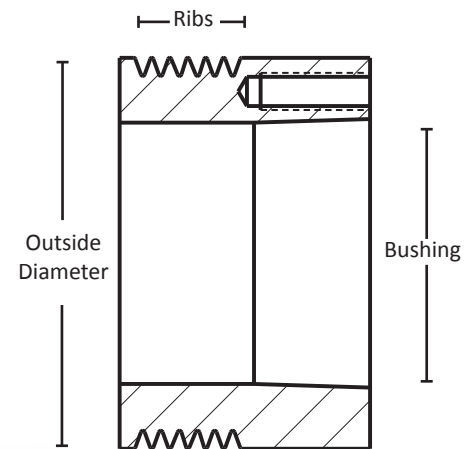

Poly V

QD[®] BUSHINGS

Steel/Iron



BORE	KEYWAY
0.500" - 0.563"	0.125" x 0.063"
0.625" - 0.875"	0.188" x 0.094"
0.938" - 1.250"	0.250" x 0.125"
1.438" - 1.750"	0.375" x 0.188"
1.813" - 2.250"	0.500" x 0.250"
2.313" - 2.750"	0.625" x 0.313"
2.813" - 3.250"	0.750" x 0.375"
3.313" - 3.750"	0.875" x 0.438"
3.813" - 4.333"	1.000" x 0.500"

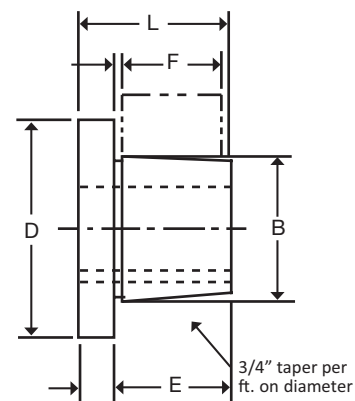

Bushing	Bore Range	Dimensions						Torque Capacity In-Lbs
		A	B	D	E	F	L	
H	0.438" - 1.500"	0.250"	1.625"	2.500"	1.000"	0.875"	1.250"	1,750
JA	0.500" - 1.250"	0.313"	1.375"	2.000"	0.688"	0.588"	1.000"	1,750
SH	0.500" - 1.625"	0.375"	1.871"	2.688"	0.875"	0.813"	1.250"	3,500
SDS	0.500" - 2.000"	0.438"	2.188"	3.188"	0.875"	0.750"	1.313"	5,000
SD	0.500" - 2.000"	0.438"	2.188"	3.188"	1.375"	1.250"	1.813"	5,000
SK	0.500" - 2.625"	0.500"	2.813"	3.875"	1.375"	1.250"	1.875"	7,000
SF	0.500" - 2.938"	0.500"	3.125"	4.625"	1.500"	1.250"	2.000"	11,000
E	0.875" - 3.500"	0.750"	3.834"	6.000"	1.875"	1.625"	2.625"	20,000
F	1.000" - 4.000"	0.813"	4.438"	6.625"	2.813"	2.500"	3.625"	40,000
J	1.500" - 4.500"	1.000"	5.148"	7.250"	3.500"	3.188"	4.500"	55,000
M	2.000" - 5.500"	1.250"	6.500"	9.125"	5.500"	5.188"	6.750"	125,000
N	2.438" - 5.875"	1.500"	7.000"	10.000"	6.625"	6.250"	8.125"	150,000
P	2.938" - 7.000"	1.750"	8.250"	11.750"	7.625"	7.250"	9.375"	250,000
W	4.250" - 8.500"	2.000"	10.437"	15.000"	9.375"	9.000"	11.375"	375,000
S	6.000" - 10.000"	3.250"	12.125"	17.750"	12.500"	12.000"	15.750"	625,000

Poly V

TAPER-LOCK® BUSHINGS

Steel/Iron



BORE	KEYWAY
0.500" - 0.563"	0.125" X 0.063"
0.625" - 0.875"	0.188" X 0.094"
0.938" - 1.250"	0.250" X 0.125"
1.438" - 1.750"	0.375" X 0.188"
1.813" - 2.250"	0.500" X 0.250"
2.313" - 2.750"	0.625" X 0.313"
2.813" - 3.250"	0.750" X 0.375"
3.313" - 3.750"	0.875" X 0.438"
3.813" - 4.500"	1.000" X 0.500"

1008 thru 3030 Sizes

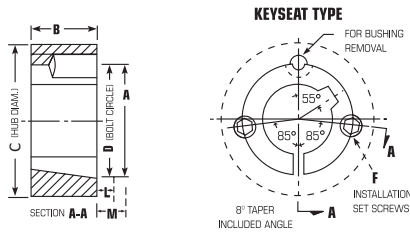

3535 thru 5050 Sizes

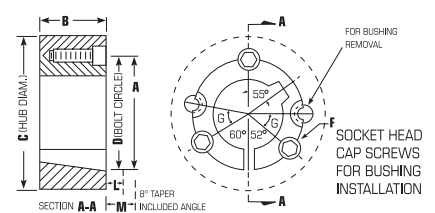

Bushing	Bore Range	Dimensions					Torque Capacity In-Lbs
		A	B	C	D	G	
1008	0.500" - 1.000"	1.375"	0.875"	2.188"	1.328"	-	1,200
1108	0.500" - 1.125"	1.500"	0.875"	2.313"	1.453"	-	1,300
1210	0.500" - 1.250"	1.875"	1.000"	3.250"	1.750"	-	3,600
1215	0.500" - 1.250"	1.875"	1.500"	2.875"	1.750"	-	3,550
1310	0.500" - 1.375"	2.000"	1.000"	3.375"	1.875"	-	3,850
1610	0.500" - 1.625"	2.250"	1.000"	3.625"	2.125"	-	4,300
1615	0.500" - 1.625"	2.250"	1.500"	3.250"	2.125"	-	4,300
2012	0.500" - 2.000"	2.750"	1.250"	4.375"	2.625"	-	7,150
2517	0.500" - 2.500"	3.375"	1.750"	4.875"	3.250"	-	11,600
2525	0.750" - 2.500"	3.375"	2.500"	4.500"	3.250"	-	11,300
3020	0.938" - 3.000"	4.250"	2.000"	6.250"	4.000"	-	24,000
3030	0.938" - 3.000"	4.250"	3.000"	5.750"	4.000"	-	24,000
3525	1.188" - 3.938"	5.000"	2.500"	7.000"	4.830"	39	44,800
3535	1.188" - 3.500"	5.000"	3.500"	7.000"	4.830"	39	44,800
4030	1.438" - 4.438"	5.750"	3.000"	8.500"	5.540"	39	77,300
4040	1.438" - 4.000"	5.750"	4.000"	8.500"	5.540"	40	77,300
4535	1.938" - 4.938"	6.375"	3.500"	9.500"	6.125"	40	110,000
4545	2.313" - 4.938"	6.375"	4.500"	9.500"	6.125"	40	110,000
5040	2.438" - 5.000"	7.000"	4.000"	10.500"	6.720"	37	126,000
5050	2.438" - 5.000"	7.000"	5.000"	10.500"	6.720"	37	126,000

Poly V

H SERIES TIMING PULLEYS

5 mm Pitch
For 9 mm Wide Belts
Hub and Flanges
Aluminum
Clear Anodized
Finished Bore

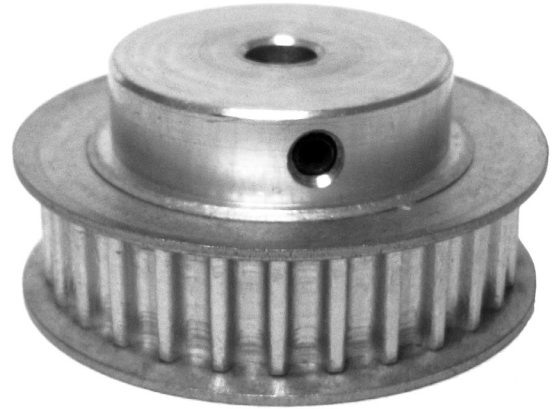

Part Number	No. of Teeth	Type	Pitch Dia. (in)	Out. Dia. (in)	Flange Dia. (in)	Bore (in)	Face (in)	Overall Length (in)	Hub Dia. (in)	Set Screw
12-5M09-6FA3	12	6F	0.752	0.707	0.875	0.250	0.547	0.797	0.437	1 x 8-32
12-5M09-6FA4	12	6F	0.752	0.707	0.875	0.313	0.547	0.797	0.437	1 x 8-32
13-5M09-6FA3	13	6F	0.815	0.770	0.937	0.250	0.547	0.797	0.500	1 x 8-32
14-5M09-6FA3	14	6F	0.877	0.832	1.000	0.250	0.547	0.797	0.500	2 x 8-32 @ 90°
15-5M09-6FA3	15	6F	0.940	0.895	1.063	0.250	0.547	0.797	0.563	2 x 8-32 @ 90°
16-5M09-6FA3	16	6F	1.003	0.958	1.094	0.250	0.547	0.797	0.563	2 x 8-32 @ 90°
16-5M09-6FA4	16	6F	1.003	0.958	1.094	0.313	0.547	0.797	0.563	2 x 8-32 @ 90°
16-5M09-6FA5	16	6F	1.003	0.958	1.094	0.375	0.547	0.797	0.563	2 x 8-32 @ 90°
17-5M09-6FA3	17	6F	1.065	1.020	1.187	0.250	0.540	0.79	0.625	2 x 8-32 @ 90°
17-5M09-6FA6	17	6F	1.065	1.020	1.187	0.500	0.540	0.79	0.625	2 x 8-32 @ 90°
18-5M09-6FA3	18	6F	1.128	1.083	1.250	0.250	0.547	0.797	0.687	2 x 8-32 @ 90°
19-5M09-6FA3	19	6F	1.191	1.146	1.312	0.250	0.547	0.797	0.750	2 x 8-32 @ 90°
19-5M09-6FA6	19	6F	1.191	1.146	1.312	0.500	0.547	0.797	0.750	2 x 8-32 @ 90°
20-5M09-6FA3	20	6F	1.253	1.208	1.375	0.250	0.540	0.790	0.812	2 x 8-32 @ 90°
22-5M09-6FA3	22	6F	1.379	1.334	1.500	0.250	0.547	0.797	0.937	2 x 8-32 @ 90°
24-5M09-6FA3	24	6F	1.504	1.459	1.625	0.250	0.540	0.852	1.000	2 x 8-32 @ 90°
25-5M09-6FA3	25	6F	1.566	1.521	1.687	0.250	0.547	0.859	1.000	2 x 8-32 @ 90°
25-5M09-6FA4	25	6F	1.566	1.521	1.687	0.313	0.547	0.859	1.000	2 x 8-32 @ 90°
26-5M09-6FA3	26	6F	1.629	1.584	1.750	0.250	0.547	0.859	1.063	2 x 8-32 @ 90°
28-5M09-6FA3	28	6F	1.754	1.709	1.875	0.250	0.540	0.852	1.187	2 x 8-32 @ 90°
28-5M09-6FA6	28	6F	1.754	1.709	1.875	0.500	0.540	0.852	1.187	2 x 8-32 @ 90°
30-5M09-6FA3	30	6F	1.880	1.835	2.000	0.250	0.547	0.859	1.187	2 x 8-32 @ 90°
30-5M09-6FA4	30	6F	1.880	1.835	2.000	0.313	0.547	0.859	1.187	2 x 8-32 @ 90°
30-5M09-6FA5	30	6F	1.880	1.835	2.000	0.375	0.547	0.859	1.187	2 x 8-32 @ 90°
32-5M09-6FA3	32	6F	2.005	1.960	2.125	0.250	0.540	0.852	1.250	2 x 8-32 @ 90°
34-5M09-6FA3	34	6F	2.130	2.085	2.250	0.250	0.547	0.859	1.375	2 x 8-32 @ 90°

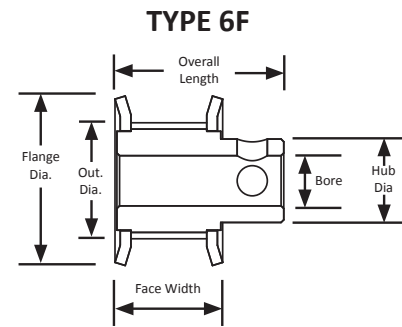

H SERIES TIMING PULLEYS

5 mm Pitch
For 9 mm Wide Belts
Hub and No Flanges
Aluminum
Clear Anodized
Finished Bore



Part Number	No. of Teeth	Type	Pitch Dia. (in)	Out. Dia. (in)	Bore (in)	Face Width (in)	Overall Length (in)	Hub Dia. (in)	Set Screw
12-5M09-6A3	12	6	0.752	0.707	0.250	0.546	0.796	0.437	1 x 8-32
13-5M09-6A3	13	6	0.815	0.770	0.250	0.546	0.796	0.500	1 x 8-32
14-5M09-6A3	14	6	0.877	0.832	0.250	0.546	0.796	0.500	2 x 8-32 @ 90°
15-5M09-6A3	15	6	0.940	0.895	0.250	0.546	0.796	0.563	2 x 8-32 @ 90°
16-5M09-6A3	16	6	1.003	0.958	0.250	0.546	0.796	0.563	2 x 8-32 @ 90°
17-5M09-6A3	17	6	1.065	1.020	0.250	0.546	0.796	0.625	2 x 8-32 @ 90°
18-5M09-6A3	18	6	1.128	1.083	0.250	0.546	0.796	0.687	2 x 8-32 @ 90°
19-5M09-6A3	19	6	1.191	1.146	0.250	0.546	0.796	0.750	2 x 8-32 @ 90°
20-5M09-6A3	20	6	1.253	1.208	0.250	0.546	0.796	0.812	2 x 8-32 @ 90°
22-5M09-6A3	22	6	1.379	1.334	0.250	0.546	0.796	0.937	2 x 8-32 @ 90°
24-5M09-6A3	24	6	1.504	1.459	0.250	0.546	0.859	1.000	2 x 8-32 @ 90°
25-5M09-6A3	25	6	1.566	1.521	0.250	0.546	0.859	1.000	2 x 8-32 @ 90°
26-5M09-6A3	26	6	1.629	1.584	0.250	0.546	0.859	1.063	2 x 8-32 @ 90°
28-5M09-6A3	28	6	1.754	1.709	0.250	0.546	0.859	1.187	2 x 8-32 @ 90°
30-5M09-6A3	30	6	1.880	1.835	0.250	0.546	0.859	1.187	2 x 8-32 @ 90°
32-5M09-6A3	32	6	2.005	1.960	0.250	0.546	0.859	1.250	2 x 8-32 @ 90°
34-5M09-6A3	34	6	2.130	2.085	0.250	0.546	0.859	1.375	2 x 8-32 @ 90°
36-5M09-6A4	36	6	2.256	2.211	0.313	0.546	0.937	1.500	2 x 8-32 @ 90°
38-5M09-6A4	38	6	2.381	2.336	0.313	0.546	0.937	1.500	2 x 8-32 @ 90°
40-5M09-6A4	40	6	2.506	2.461	0.313	0.546	0.937	1.500	2 x 8-32 @ 90°
44-5M09-6A4	44	6	2.757	2.712	0.313	0.546	0.937	1.500	2 x 8-32 @ 90°
48-5M09-6A5	48	6	3.008	2.963	0.375	0.546	0.937	1.500	2 x 10-32 @ 90°
50-5M09-6A5	50	6	3.133	3.088	0.375	0.546	0.937	1.500	2 x 10-32 @ 90°
56-5M09-6A5	56	6	3.509	3.464	0.375	0.546	0.937	1.500	2 x 10-32 @ 90°
60-5M09-6A5	60	6	3.760	3.715	0.375	0.546	0.937	1.500	2 x 10-32 @ 90°
62-5M09-6A5	62	6	3.885	3.840	0.375	0.546	0.937	1.500	2 x 10-32 @ 90°
70-5M09-6A5	70	6	4.386	4.341	0.375	0.546	0.937	1.500	2 x 10-32 @ 90°
72-5M09-6A5	72	6	4.511	4.466	0.375	0.546	0.937	1.500	2 x 10-32 @ 90°

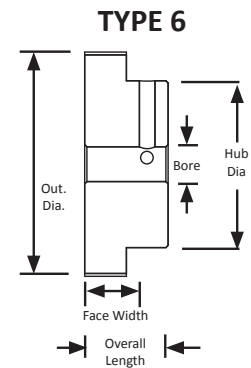

H SERIES TIMING PULLEYS

5 mm Pitch
For 15 mm Wide Belts
Hub and Flanges
Aluminum
Clear Anodized
Finished Bore

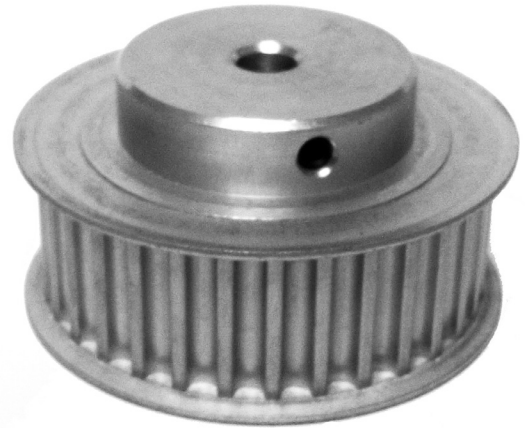

Part Number	No. of Teeth	Type	Pitch Dia. (in)	Out. Dia. (in)	Flange Dia. (in)	Bore (in)	Face Width (in)	Overall Length (in)	Hub Dia. (in)	Set Screw
12-5M15-6FA3	12	6F	0.752	0.707	0.875	0.250	0.780	1.025	0.437	1 x 8-32
13-5M15-6FA3	13	6F	0.815	0.770	0.937	0.250	0.780	1.025	0.500	1 x 8-32
14-5M15-6FA3	14	6F	0.877	0.832	1.000	0.250	0.780	1.025	0.500	2 x 8-32 @ 90°
15-5M15-6FA3	15	6F	0.940	0.895	1.063	0.250	0.780	1.025	0.563	2 x 8-32 @ 90°
16-5M15-6FA3	16	6F	1.003	0.958	1.094	0.250	0.780	1.025	0.563	2 x 8-32 @ 90°
17-5M15-6FA3	17	6F	1.065	1.020	1.187	0.250	0.780	1.025	0.625	2 x 8-32 @ 90°
18-5M15-6FA3	18	6F	1.128	1.083	1.250	0.250	0.780	1.025	0.687	2 x 8-32 @ 90°
18-5M15-6FA5	18	6F	1.128	1.083	1.250	0.375	0.780	1.025	0.687	2 x 8-32 @ 90°
19-5M15-6FA3	19	6F	1.191	1.146	1.312	0.250	0.780	1.025	0.750	2 x 8-32 @ 90°
20-5M15-6FA3	20	6F	1.253	1.208	1.375	0.250	0.780	1.025	0.812	2 x 8-32 @ 90°
20-5M15-6FA5	20	6F	1.253	1.208	1.375	0.375	0.780	1.025	0.812	2 x 8-32 @ 90°
22-5M15-6FA3	22	6F	1.379	1.334	1.500	0.250	0.780	1.025	0.937	2 x 8-32 @ 90°
24-5M15-6FA3	24	6F	1.504	1.459	1.625	0.250	0.780	1.087	1.000	2 x 8-32 @ 90°
25-5M15-6FA3	25	6F	1.566	1.521	1.687	0.250	0.780	1.087	1.000	2 x 8-32 @ 90°
26-5M15-6FA3	26	6F	1.629	1.584	1.750	0.250	0.780	1.087	1.063	2 x 8-32 @ 90°
28-5M15-6FA3	28	6F	1.754	1.709	1.875	0.250	0.780	1.087	1.187	2 x 8-32 @ 90°
30-5M15-6FA3	30	6F	1.880	1.835	2.000	0.250	0.780	1.087	1.187	2 x 8-32 @ 90°
32-5M15-6FA3	32	6F	2.005	1.960	2.125	0.250	0.780	1.087	1.250	2 x 8-32 @ 90°
34-5M15-6FA3	34	6F	2.130	2.085	2.250	0.250	0.780	1.087	1.375	2 x 8-32 @ 90°

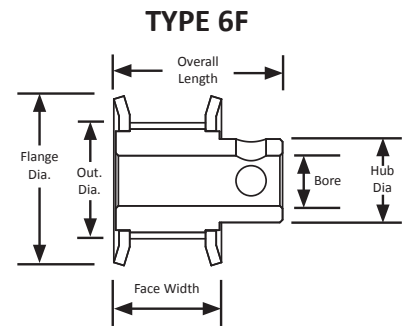

H SERIES TIMING PULLEYS

5 mm Pitch
For 15 mm Wide Belts
Hub and No Flanges
Aluminum
Clear Anodized
Finished Bore

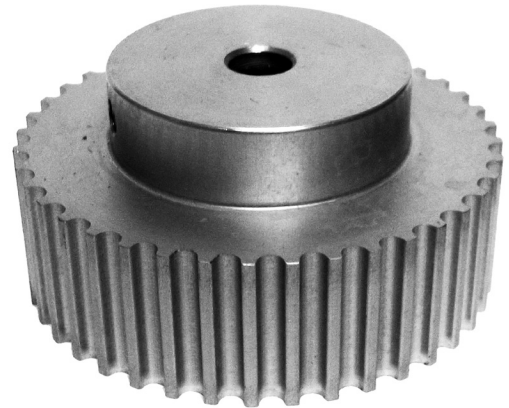

Part Number	No. of Teeth	Type	Pitch Dia. (in)	Out. Dia. (in)	Bore (in)	Face Width (in)	Overall Length (in)	Hub Dia. (in)	Set Screw
12-5M15-6A3	12	6	0.752	0.707	0.250	0.781	1.032	0.437	2 x 8-32 @ 90°
13-5M15-6A3	13	6	0.815	0.770	0.250	0.781	1.032	0.500	2 x 8-32 @ 90°
14-5M15-6A3	14	6	0.877	0.832	0.250	0.781	1.032	0.500	2 x 8-32 @ 90°
15-5M15-6A3	15	6	0.94	0.895	0.250	0.781	1.032	0.563	2 x 8-32 @ 90°
16-5M15-6A3	16	6	1.003	0.958	0.250	0.781	1.032	0.563	2 x 8-32 @ 90°
17-5M15-6A3	17	6	1.065	1.020	0.250	0.781	1.032	0.625	2 x 8-32 @ 90°
18-5M15-6A3	18	6	1.128	1.083	0.250	0.781	1.032	0.687	2 x 8-32 @ 90°
19-5M15-6A3	19	6	1.191	1.146	0.250	0.781	1.032	0.750	2 x 8-32 @ 90°
20-5M15-6A3	20	6	1.253	1.208	0.250	0.781	1.032	0.812	2 x 8-32 @ 90°
22-5M15-6A3	22	6	1.379	1.334	0.250	0.781	1.032	0.937	2 x 8-32 @ 90°
24-5M15-6A3	24	6	1.504	1.459	0.250	0.781	1.093	1.000	2 x 8-32 @ 90°
25-5M15-6A3	25	6	1.566	1.521	0.250	0.781	1.093	1.000	2 x 8-32 @ 90°
26-5M15-6A3	26	6	1.629	1.584	0.250	0.781	1.093	1.063	2 x 8-32 @ 90°
28-5M15-6A3	28	6	1.754	1.709	0.250	0.781	1.093	1.187	2 x 8-32 @ 90°
30-5M15-6A3	30	6	1.880	1.835	0.250	0.781	1.093	1.187	2 x 8-32 @ 90°
32-5M15-6A3	32	6	2.005	1.960	0.250	0.781	1.093	1.250	2 x 8-32 @ 90°
34-5M15-6A3	34	6	2.130	2.085	0.250	0.781	1.093	1.375	2 x 8-32 @ 90°
36-5M15-6A4	36	6	2.256	2.211	0.313	0.781	1.187	1.500	2 x 8-32 @ 90°
36-5M15-6A6	36	6	2.256	2.211	0.500	0.781	1.187	1.500	2 x 8-32 @ 90°
38-5M15-6A4	38	6	2.381	2.336	0.313	0.781	1.187	1.500	2 x 8-32 @ 90°
40-5M15-6A4	40	6	2.506	2.461	0.313	0.781	1.187	1.500	2 x 8-32 @ 90°
44-5M15-6A4	44	6	2.757	2.712	0.313	0.781	1.187	1.500	2 x 8-32 @ 90°
48-5M15-6A5	48	6	3.008	2.963	0.375	0.781	1.187	1.500	2 x 10-32 @ 90°
50-5M15-6A5	50	6	3.133	3.088	0.375	0.781	1.187	1.500	2 x 10-32 @ 90°
56-5M15-6A5	56	6	3.509	3.464	0.375	0.781	1.187	1.500	2 x 10-32 @ 90°
56-5M15-6A6	56	6	3.509	3.464	0.500	0.781	1.187	1.500	2 x 10-32 @ 90°
60-5M15-6A5	60	6	3.760	3.715	0.375	0.781	1.187	1.500	2 x 10-32 @ 90°
62-5M15-6A5	62	6	3.885	3.840	0.375	0.781	1.187	1.500	2 x 10-32 @ 90°
70-5M15-6A5	70	6	4.386	4.341	0.375	0.781	1.187	1.500	2 x 10-32 @ 90°
72-5M15-6A5	72	6	4.511	4.466	0.375	0.781	1.187	1.500	2 x 10-32 @ 90°
72-5M15-6A6	72	6	4.511	4.466	0.500	0.781	1.187	1.500	2 x 10-32 @ 90°

TYPE 6

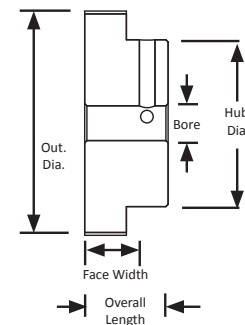

Have you ever wondered why there are timing pulleys without flanges?

When aligned properly, timing pulley flanges are only required on the smaller timing pulley of a synchronous belt drive when the distance between the centers of the two timing pulleys is less than 8 times the diameter of the smaller timing pulley. This allows for the larger timing pulley of the drive to be flangeless. A flangeless larger timing pulley saves the cost of the larger timing pulley flanges from the synchronous drive and allows for a little more clearance in tight fit applications.

H SERIES TIMING PULLEYS

5 mm Pitch

For 15 mm Wide Belts

Steel/Iron

Black Oxide Plating



Part Number	No. of Teeth	Type	Pitch Dia. (in)	Out. Dia. (in)	Flange Dia. (in)	Bore / Bushing	Face Width (in)	Overall Length (in)	Hub Dia. (in)
32-5M15-6FS6	32	6F	2.005	1.960	2.125	0.500"	0.840	1.340	0.425
34-5M15-6FS6	34	6F	2.130	2.085	2.375	0.500"	0.840	1.340	0.450
36-5M15-6FS6	36	6F	2.256	2.211	2.375	0.500"	0.840	1.340	0.480
QD38-5M-15	38	E1F	2.381	2.336	2.625	JA	0.840	0.840	0.312
QD40-5M-15	40	E1F	2.506	2.461	2.750	JA	0.840	0.840	0.635
QD44-5M-15	44	E1F	2.757	2.712	3.094	JA	0.840	0.840	0.364
QD48-5M-15	48	C1F	3.008	2.963	3.330	JA	0.840	0.840	0.685
QD52-5M-15	52	C1F	3.258	3.213	3.566	JA	0.840	0.840	0.390
QD56-5M-15	56	D1F	3.509	3.464	3.800	SH	0.840	0.840	0.710
QD60-5M-15	60	D1F	3.760	3.715	4.044	SH	0.840	0.840	0.390
QD64-5M-15	64	D1F	4.010	3.965	4.170	SH	0.840	0.840	0.740
QD68-5M-15	68	C1F	4.261	4.216	4.520	SDS	0.840	0.840	0.442
QD72-5M-15	72	C1F	4.511	4.466	4.670	SDS	0.840	0.840	0.494
QD80-5M-15	80	C1F	5.013	4.968	-	SDS	0.840	0.840	0.546
QD90-5M-15	90	C1F	5.639	5.594	-	SDS	0.840	0.840	0.598
QD112-5M-15	112	C1F	7.018	6.973	-	SDS	0.840	0.840	0.676

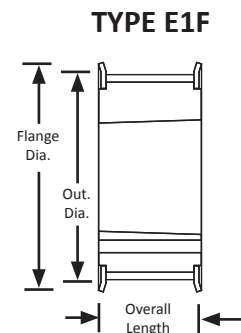
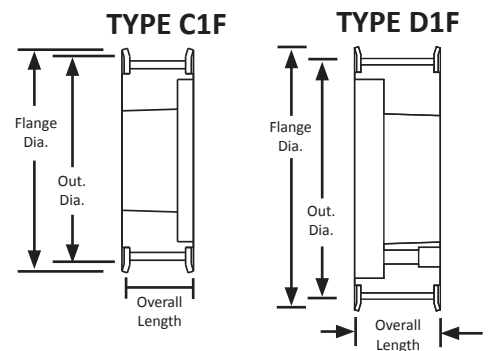
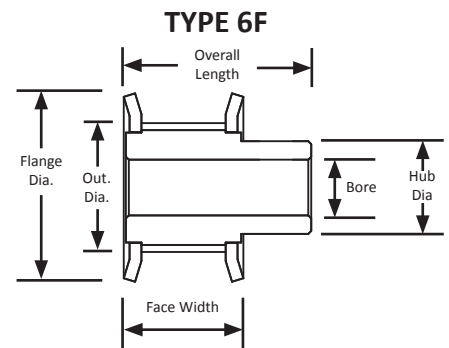

H SERIES TIMING PULLEYS

5 mm Pitch

For 25 mm Wide Belts

Steel/Iron

Black Oxide Plating



Part Number	No. of Teeth	Type	Pitch Dia. (in)	Out. Dia. (in)	Flange Dia. (in)	Bore / Bushing	Face Width (in)	Overall Length (in)	Hub Dia. (in)
32-5M25-6FS6	32	6F	2.005	1.960	2.125	0.500"	1.230	1.730	1.550
34-5M25-6FS6	34	6F	2.130	2.085	2.375	0.500"	1.230	1.730	1.680
36-5M25-6FS6	36	6F	2.256	2.211	2.375	0.500"	1.230	1.730	1.800
QD38-5M-25	38	E1F	2.381	2.336	2.625	JA	1.230	1.230	-
QD40-5M-25	40	E1F	2.506	2.461	2.750	JA	1.230	1.230	-
QD44-5M-25	44	E1F	2.757	2.712	3.094	JA	1.230	1.230	-
QD48-5M-25	48	B1F	3.008	2.963	3.330	JA	1.230	1.230	-
QD52-5M-25	52	B1F	3.258	3.213	3.566	JA	1.230	1.230	-
QD56-5M-25	56	D1F	3.509	3.464	3.800	SH	1.230	1.230	-
QD60-5M-25	60	D1F	3.760	3.715	4.044	SH	1.230	1.230	-
QD64-5M-25	64	D1F	4.010	3.965	4.170	SH	1.230	1.230	-
QD68-5M-25	68	C1F	4.261	4.216	4.520	SDS	1.230	1.230	-
QD72-5M-25	72	C1F	4.511	4.466	4.670	SDS	1.230	1.230	-
QD80-5M-25	80	C1F	5.013	4.968	-	SDS	1.230	1.230	-
QD90-5M-25	90	C1F	5.639	5.594	-	SDS	1.230	1.230	-
QD112-5M-25	112	D2	7.018	6.973	-	SDS	1.230	1.230	-

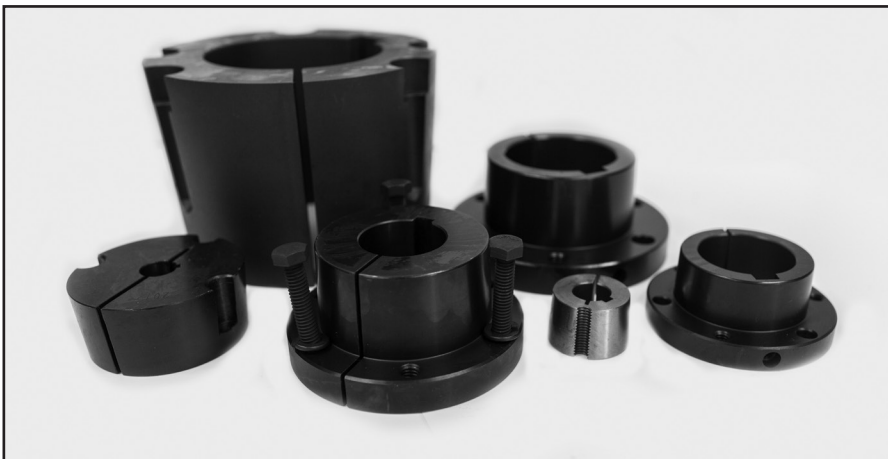
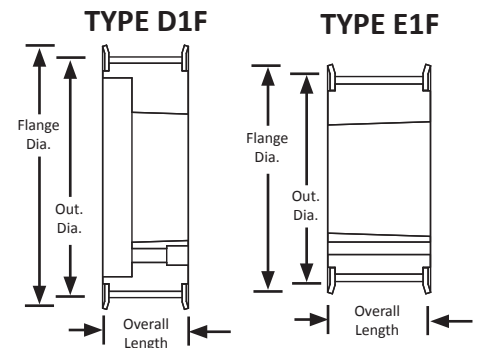
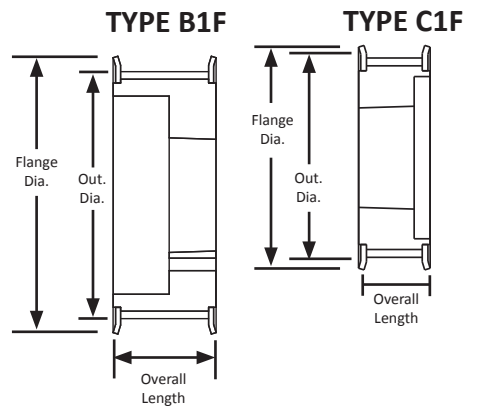
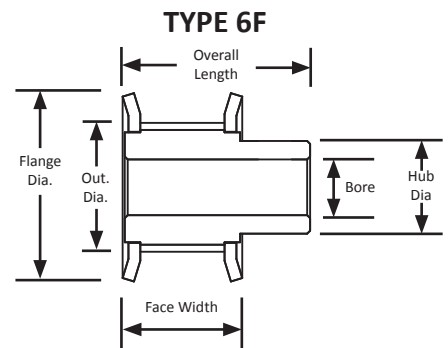

For matching QD® bushings, see page 89.

H SERIES TIMING PULLEYS

5 mm Pitch
For 9 mm Wide Belts
Hub and Flanges
Aluminum
Clear Anodized
Metric Finished Bore

METRIC TIMING PULLEY



Part Number	No. of Teeth	Type	Pitch Dia. (mm)	Out. Dia. (mm)	Flange Dia. (mm)	Bore (mm)	Face Width (mm)	Overall Length (mm)	Hub Dia. (mm)	Key Way
12-5M09M6FA6	12	6F	19.1	18.0	22.2	6.0	13.9	20.2	11.1	1 x M3
13-5M09M6FA6	13	6F	20.7	19.6	23.8	6.0	13.9	20.2	12.7	1 x M3
14-5M09M6FA6	14	6F	22.2	21.1	25.4	6.0	13.9	20.2	12.7	2 x M3 @ 90°
15-5M09M6FA6	15	6F	23.8	22.7	27.0	6.0	13.9	20.2	14.3	2 x M3 @ 90°
16-5M09M6FA6	16	6F	25.4	24.3	27.8	6.0	13.9	20.2	14.3	2 x M3 @ 90°
17-5M09M6FA8	17	6F	27.0	25.9	30.2	8.0	13.9	20.2	15.9	2 x M4 @ 90°
18-5M09M6FA8	18	6F	28.6	27.5	31.8	8.0	13.9	20.2	17.5	2 x M4 @ 90°
19-5M09M6FA8	19	6F	30.2	29.1	33.3	8.0	13.9	20.2	19.1	2 x M4 @ 90°
20-5M09M6FA8	20	6F	31.8	30.7	34.9	8.0	13.9	20.2	20.6	2 x M4 @ 90°
22-5M09M6FA8	22	6F	35.0	33.9	38.1	8.0	13.9	20.2	23.8	2 x M4 @ 90°
24-5M09M6FA8	24	6F	38.2	37.1	41.3	8.0	13.9	21.8	25.4	2 x M4 @ 90°
25-5M09M6FA8	25	6F	39.8	38.7	42.9	8.0	13.9	21.8	25.4	2 x M4 @ 90°
26-5M09M6FA8	26	6F	41.4	40.2	44.5	8.0	13.9	21.8	27.0	2 x M4 @ 90°
28-5M09M6FA8	28	6F	44.5	43.4	47.6	8.0	13.9	21.8	30.2	2 x M4 @ 90°
30-5M09M6FA8	30	6F	47.8	46.6	50.8	8.0	13.9	21.8	30.2	2 x M4 @ 90°
32-5M09M6FA8	32	6F	50.9	49.8	54.0	8.0	13.9	21.8	31.8	2 x M4 @ 90°
34-5M09M6FA8	34	6F	54.1	53.0	57.2	8.0	13.9	21.8	35.0	2 x M4 @ 90°

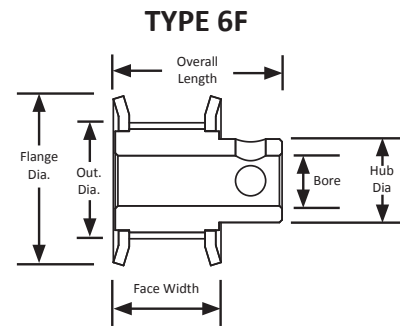

PTDA

*Channeling the
Power of Industry*



H SERIES TIMING PULLEYS

5 mm Pitch
For 9 mm Wide Belts
Hub and No Flanges
Aluminum
Clear Anodized
Metric Finished Bore

METRIC TIMING PULLEY



Part Number	No. of Teeth	Type	Pitch Dia (mm)	Out. Dia (mm)	Bore (mm)	Face Width (mm)	Overall Length (mm)	Hub Dia. (mm)	Set Screw
12-5M09M6A6	12	6	19.1	18.0	6.0	13.9	20.2	11.1	1 x M3
13-5M09M6A6	13	6	20.7	19.6	6.0	13.9	20.2	12.7	1 x M3
14-5M09M6A6	14	6	22.2	21.1	6.0	13.9	20.2	12.7	2 x M3 @ 90°
15-5M09M6A6	15	6	23.8	22.7	6.0	13.9	20.2	14.3	2 x M3 @ 90°
16-5M09M6A6	16	6	25.4	24.3	6.0	13.9	20.2	14.3	2 x M3 @ 90°
17-5M09M6A8	17	6	27.0	25.9	8.0	13.9	20.2	15.9	2 x M4 @ 90°
18-5M09M6A8	18	6	28.6	27.5	8.0	13.9	20.2	17.5	2 x M4 @ 90°
19-5M09M6A8	19	6	30.2	29.1	8.0	13.9	20.2	19.1	2 x M4 @ 90°
20-5M09M6A8	20	6	31.8	30.7	8.0	13.9	20.2	20.6	2 x M4 @ 90°
22-5M09M6A8	22	6	35.0	33.9	8.0	13.9	20.2	23.8	2 x M4 @ 90°
24-5M09M6A8	24	6	38.2	37.1	8.0	13.9	21.8	25.4	2 x M4 @ 90°
25-5M09M6A8	25	6	39.8	38.7	8.0	13.9	21.8	25.4	2 x M4 @ 90°
26-5M09M6A8	26	6	41.4	40.2	8.0	13.9	21.8	27.0	2 x M4 @ 90°
28-5M09M6A8	28	6	44.5	43.4	8.0	13.9	21.8	30.2	2 x M4 @ 90°
30-5M09M6A8	30	6	47.8	46.6	8.0	13.9	21.8	30.2	2 x M4 @ 90°
32-5M09M6A8	32	6	50.9	49.8	8.0	13.9	21.8	31.8	2 x M4 @ 90°
34-5M09M6A8	34	6	54.1	53.0	8.0	13.9	21.8	35.0	2 x M4 @ 90°
36-5M09M6A10	36	6	57.3	56.2	10.0	13.9	23.8	38.1	2 x M5 @ 90°
38-5M09M6A10	38	6	60.5	59.3	10.0	13.9	23.8	38.1	2 x M5 @ 90°
40-5M09M6A10	40	6	63.6	62.5	10.0	13.9	23.8	38.1	2 x M5 @ 90°
44-5M09M6A10	44	6	70.0	68.9	10.0	13.9	23.8	38.1	2 x M5 @ 90°
48-5M09M6A12	48	6	76.4	75.3	12.0	13.9	23.8	38.1	2 x M6 @ 90°
50-5M09M6A12	50	6	79.6	78.4	12.0	13.9	23.8	38.1	2 x M6 @ 90°
56-5M09M6A12	56	6	89.1	88.0	12.0	13.9	23.8	38.1	2 x M6 @ 90°
60-5M09M6A12	60	6	95.5	94.4	12.0	13.9	23.8	38.1	2 x M6 @ 90°
62-5M09M6A12	62	6	98.7	97.5	12.0	13.9	23.8	38.1	2 x M6 @ 90°
70-5M09M6A12	70	6	111.4	110.3	12.0	13.9	23.8	38.1	2 x M6 @ 90°
72-5M09M6A12	72	6	114.6	113.5	12.0	13.9	23.8	38.1	2 x M6 @ 90°

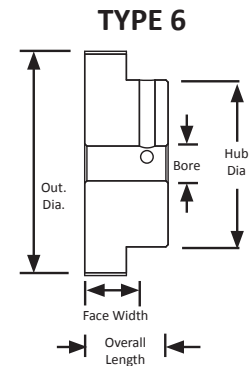

H SERIES TIMING PULLEYS

5 mm Pitch
For 15 mm Wide Belts
Hub and Flanges
Aluminum
Clear Anodized
Metric Finished Bore

METRIC TIMING PULLEY



Part Number	No. of Teeth	Type	Pitch Dia. (mm)	Out. Dia. (mm)	Flange Dia. (mm)	Bore (mm)	Face Width (mm)	Overall Length (mm)	Hub Dia. (mm)	Set Screw
12-5M15M6FA6	12	6F	19.1	18.0	22.2	6.0	19.8	26.2	11.1	1 x M3
13-5M15M6FA6	13	6F	20.7	19.6	23.8	6.0	19.8	26.2	12.7	1 x M3
14-5M15M6FA6	14	6F	22.2	21.1	25.4	6.0	19.8	26.2	12.7	2 x M3 @ 90°
15-5M15M6FA6	15	6F	23.8	22.7	27.0	6.0	19.8	26.2	14.3	2 x M3 @ 90°
16-5M15M6FA6	16	6F	25.4	24.3	27.8	6.0	19.8	26.2	14.3	2 x M3 @ 90°
17-5M15M6FA8	17	6F	27.0	25.9	30.2	8.0	19.8	26.2	15.9	2 x M4 @ 90°
18-5M15M6FA8	18	6F	28.6	27.5	31.8	8.0	19.8	26.2	17.5	2 x M4 @ 90°
19-5M15M6FA8	19	6F	30.2	29.1	33.3	8.0	19.8	26.2	19.1	2 x M4 @ 90°
20-5M15M6FA8	20	6F	31.8	30.7	34.9	8.0	19.8	26.2	20.6	2 x M4 @ 90°
22-5M15M6FA8	22	6F	35.0	33.9	38.1	8.0	19.8	26.2	23.8	2 x M4 @ 90°
24-5M15M6FA8	24	6F	38.2	37.1	41.3	8.0	19.8	27.8	25.4	2 x M4 @ 90°
25-5M15M6FA8	25	6F	39.8	38.7	42.9	8.0	19.8	27.8	25.4	2 x M4 @ 90°
26-5M15M6FA8	26	6F	41.4	40.2	44.5	8.0	19.8	27.8	27.0	2 x M4 @ 90°
28-5M15M6FA8	28	6F	44.5	43.4	47.6	8.0	19.8	27.8	30.2	2 x M4 @ 90°
30-5M15M6FA8	30	6F	47.8	46.6	50.8	8.0	19.8	27.8	30.2	2 x M4 @ 90°
32-5M15M6FA8	32	6F	50.9	49.8	54.0	8.0	19.8	27.8	31.8	2 x M4 @ 90°
34-5M15M6FA8	34	6F	54.1	53.0	57.2	8.0	19.8	27.8	35.0	2 x M4 @ 90°

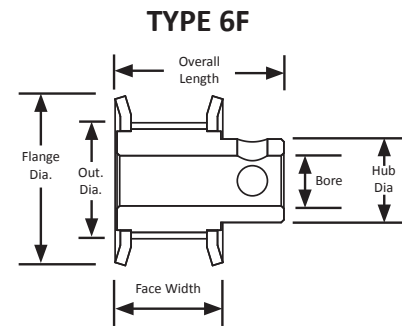

Plain bores, often referred to as minimum plain bores or MPB, are simply untapered bores drilled through the center of a pulley, gear, sprocket, or sheave. Sometimes component part numbers use MPB to designate the plain bore style.

Finished bores are plain bores with the addition of either a keyway, set screws, or both. Timing pulleys and roller chain sprockets often use a F in the part number to illustrate a finished bore.

A keyway is a slot cut into a pulley, gear, sprocket, or sheave to accept a key that engages with a similar slot on a shaft to prohibit the relative motion of the two components. Keys connecting shafts to pulley hubs are commonly used to achieve reliable no-slip power transmission in belt drive systems.

A set screw is a screw through the pulley, gear, sprocket, or sheave used to tighten the component to the shaft and limit slippage. Typically, set screws are used on larger diameter components as they typically transmit higher loads.

There are some advantages to having a plain bore. With a plain bore, it is easier to customize how the component is affixed to the shaft. A plain bore can be opened to a larger bore diameter, can be made into a finished bore, or can even be customized in other ways such as incorporating pins or screws.

There are also advantages to having a finished bore. The most noteworthy advantage is the increased prevention of shaft slippage. It allows for the component to move larger loads with increased accuracy. A noteworthy disadvantage is in the food and beverage industry where set screw holes will at times fill with debris depending on the application.

H SERIES TIMING PULLEYS

5 mm Pitch
For 15 mm Wide Belts
Hub and No Flanges
Aluminum
Clear Anodized
Metric Finished Bore

METRIC TIMING PULLEY



Part Number	No. of Teeth	Type	Pitch Dia. (mm)	Out. Dia. (mm)	Bore (mm)	Face Width (mm)	Overall Length (mm)	Hub Dia. (mm)	Set Screw
12-5M15M6A6	12	6	19.1	18.0	6.0	19.8	26.2	11.1	1 x M3
13-5M15M6A6	13	6	20.7	19.6	6.0	19.8	26.2	12.7	1 x M3
14-5M15M6A6	14	6	22.2	21.1	6.0	19.8	26.2	12.7	2 x M3 @ 90°
15-5M15M6A6	15	6	23.8	22.7	6.0	19.8	26.2	14.3	2 x M3 @ 90°
16-5M15M6A6	16	6	25.4	24.3	6.0	19.8	26.2	14.3	2 x M3 @ 90°
17-5M15M6A8	17	6	27.0	25.9	8.0	19.8	26.2	15.9	2 x M4 @ 90°
18-5M15M6A8	18	6	28.6	27.5	8.0	19.8	26.2	17.5	2 x M4 @ 90°
19-5M15M6A8	19	6	30.2	29.1	8.0	19.8	26.2	19.1	2 x M4 @ 90°
20-5M15M6A8	20	6	31.8	30.7	8.0	19.8	26.2	20.6	2 x M4 @ 90°
22-5M15M6A8	22	6	35.0	33.9	8.0	19.8	26.2	23.8	2 x M4 @ 90°
24-5M15M6A8	24	6	38.2	37.1	8.0	19.8	27.8	25.4	2 x M4 @ 90°
25-5M15M6A8	25	6	39.8	38.7	8.0	19.8	27.8	25.4	2 x M4 @ 90°
26-5M15M6A8	26	6	41.4	40.2	8.0	19.8	27.8	27.0	2 x M4 @ 90°
28-5M15M6A8	28	6	44.5	43.4	8.0	19.8	27.8	30.2	2 x M4 @ 90°
30-5M15M6A8	30	6	47.8	46.6	8.0	19.8	27.8	30.2	2 x M4 @ 90°
32-5M15M6A8	32	6	50.9	49.8	8.0	19.8	27.8	31.8	2 x M4 @ 90°
34-5M15M6A8	34	6	54.1	53.0	8.0	19.8	27.8	35.0	2 x M4 @ 90°
36-5M15M6A10	36	6	57.3	56.2	10.0	19.8	30.1	38.1	2 x M5 @ 90°
38-5M15M6A10	38	6	60.5	59.3	10.0	19.8	30.1	38.1	2 x M5 @ 90°
40-5M15M6A10	40	6	63.6	62.5	10.0	19.8	30.1	38.1	2 x M5 @ 90°
44-5M15M6A10	44	6	70.0	68.9	10.0	19.8	30.1	38.1	2 x M5 @ 90°
48-5M15M6A12	48	6	76.4	75.3	12.0	19.8	30.1	38.1	2 x M6 @ 90°
50-5M15M6A12	50	6	79.6	78.4	12.0	19.8	30.1	38.1	2 x M6 @ 90°
56-5M15M6A12	56	6	89.1	88.0	12.0	19.8	30.1	38.1	2 x M6 @ 90°
60-5M15M6A12	60	6	95.5	94.4	12.0	19.8	30.1	38.1	2 x M6 @ 90°
62-5M15M6A12	62	6	98.7	97.5	12.0	19.8	30.1	38.1	2 x M6 @ 90°
70-5M15M6A12	70	6	111.4	110.3	12.0	19.8	30.1	38.1	2 x M6 @ 90°
72-5M15M6A12	72	6	114.6	113.5	12.0	19.8	30.1	38.1	2 x M6 @ 90°

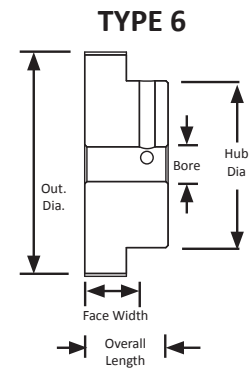

H SERIES TIMING PULLEYS

8 mm Pitch

For 20 mm Wide Belts

Steel/Iron

Black Oxide Plating



Part Number	No. of Teeth	Type	Pitch Dia. (in)	Out. Dia. (in)	Flange Dia. (in)	Bore / Bushing	Face Width (in)	Overall Length (in)	Hub Dia. (in)
22-8M20-6FS6	22	6F	2.206	2.152	2.559	0.500"	1.125	1.125	1.625
QD24-8M-20	24	E1F	2.406	2.352	2.756	JA	1.125	1.125	-
QD26-8M-20	26	E1F	2.607	2.553	2.953	JA	1.125	1.125	-
QD28-8M-20	28	3F	2.807	2.759	3.150	H	1.125	1.125	-
QD30-8M-20	30	E1F	3.008	2.958	3.346	H	1.125	1.125	-
QD32-8M-20	32	C1F	3.208	3.156	3.543	SH	1.125	1.125	-
QD34-8M-20	34	D1F	3.409	3.355	3.819	SH	1.125	1.125	-
QD36-8M-20	36	D1F	3.609	3.555	3.937	SH	1.125	1.125	-
QD38-8M-20	38	3F	3.810	3.756	4.134	SH	1.125	1.125	-
QD40-8M-20	40	D1F	4.010	3.956	4.331	SH	1.125	1.125	-
QD44-8M-20	44	C1F	4.411	4.357	4.764	SDS	1.125	1.125	-
QD48-8M-20	48	C1F	4.812	4.758	5.157	SDS	1.125	1.125	-
QD56-8M-20	56	C1F	5.614	5.560	5.945	SDS	1.125	1.125	-
QD64-8M-20	64	C1F	6.416	6.362	6.772	SDS	1.125	1.125	-
QD72-8M-20	72	C2F	7.218	7.164	7.598	SDS	1.125	1.125	-
QD80-8M-20	80	C2F	8.020	7.966	8.386	SDS	1.125	1.125	-
QD90-8M-20	90	D2	9.023	8.969	-	SDS	1.125	1.125	-
QD112-8M-20	112	C3	11.229	11.175	-	SK	1.125	1.125	-

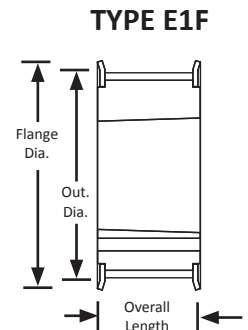
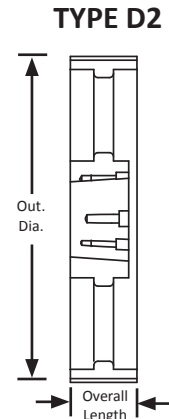
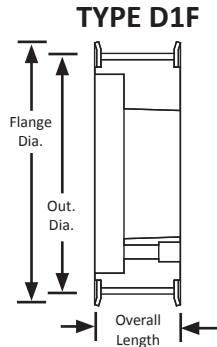
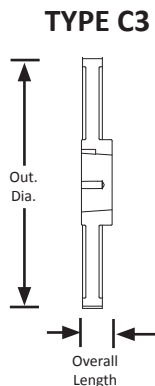
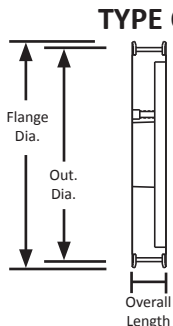
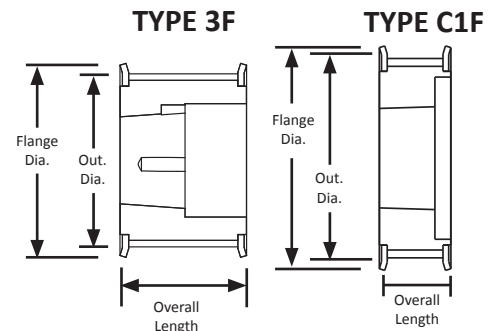
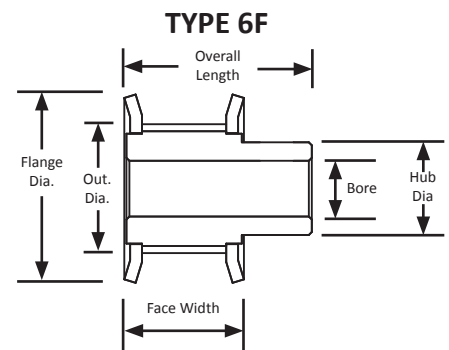

H SERIES TIMING PULLEYS

8 mm Pitch

For 30 mm Wide Belts

With Flanges

Steel/Iron

Black Oxide Plating



Part Number	No. of Teeth	Type	Pitch Dia. (in)	Out. Dia. (in)	Flange Dia. (in)	Bore / Bushing	Face Width (in)	Overall Length (in)	Hub Dia. (in)
22-8M30-6FS6	22	6F	2.206	2.152	2.559	0.500"	1.500	1.500	1.625
24-8M30-6FS6	24	6F	2.406	2.352	2.756	0.500"	1.500	1.500	1.812
26-8M30-6FS6	26	6F	2.607	2.553	2.953	0.500"	1.500	1.500	2.000
QD28-8M-30	28	E1F	2.807	2.759	3.150	H	1.500	1.500	-
QD30-8M-30	30	E1F	3.008	2.958	3.346	H	1.500	1.500	-
QD32-8M-30	32	B1F	3.208	3.156	3.543	H	1.500	1.500	-
QD34-8M-30	34	A1F	3.409	3.355	3.819	SH	1.500	1.500	-
QD36-8M-30	36	A1F	3.609	3.555	3.937	SH	1.500	1.500	-
QD38-8M-30	38	A1F	3.810	3.756	4.134	SH	1.500	1.500	-
QD40-8M-30	40	A1F	4.010	3.956	4.331	SH	1.500	1.500	-
QD44-8M-30	44	B1F	4.411	4.357	4.764	SDS	1.500	1.500	-
QD48-8M-30	48	B1F	4.812	4.758	5.157	SDS	1.500	1.500	-
QD56-8M-30	56	B1F	5.614	5.560	5.945	SDS	1.500	1.500	-
QD64-8M-30	64	C1F	6.416	6.362	6.772	SK	1.500	1.500	-
QD72-8M-30	72	C2F	7.218	7.164	7.598	SK	1.500	1.500	-
QD80-8M-30	80	C2F	8.020	7.966	8.386	SK	1.500	1.500	-
QD90-8M-30	90	C2	9.023	8.969	-	SK	1.500	1.500	-
QD112-8M-30	112	C2	11.229	11.175	-	SK	1.500	1.500	-

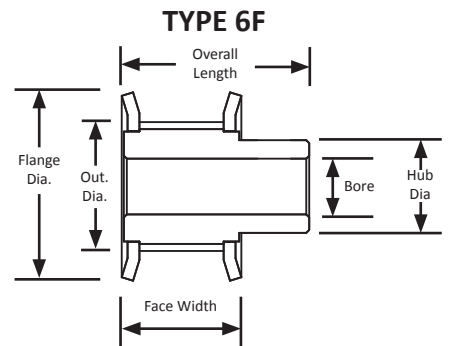
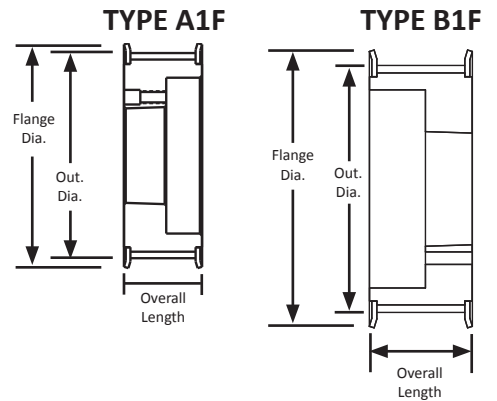

For matching QD® bushings, see page 89.

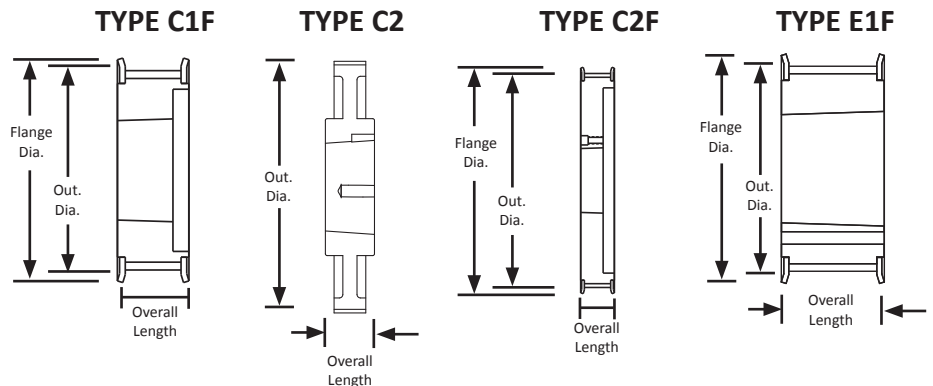

H SERIES TIMING PULLEYS

8 mm Pitch

For 50 mm Wide Belts

Steel/Iron

Black Oxide Plating

QD® Style



Part Number	No. of Teeth	Type	Pitch Dia. (in)	Out. Dia. (in)	Flange Dia. (in)	Bore / Bushing	Face Width (in)	Overall Length (in)
QD28-8M-50	28	D1F	2.807	2.759	3.150	JA	2.375	2.375
QD30-8M-50	30	D1F	3.008	2.958	3.346	JA	2.375	2.375
QD32-8M-50	32	A1F	3.208	3.156	3.543	H	2.375	2.375
QD34-8M-50	34	A1F	3.409	3.355	3.819	SH	2.375	2.375
QD36-8M-50	36	A1F	3.609	3.555	3.937	SH	2.375	2.375
QD38-8M-50	38	A1F	3.810	3.756	4.134	SH	2.375	2.375
QD40-8M-50	40	A1F	4.010	3.956	4.331	SH	2.375	2.375
QD44-8M-50	44	A1F	4.411	4.357	4.764	SD	2.375	2.375
QD48-8M-50	48	A1F	4.812	4.758	5.157	SD	2.375	2.375
QD56-8M-50	56	D1F	5.614	5.560	5.945	SK	2.375	2.375
QD64-8M-50	64	D1F	6.416	6.362	6.772	SK	2.375	2.375
QD72-8M-50	72	D1F	7.218	7.164	7.598	SK	2.375	2.375
QD80-8M-50	80	D2F	8.020	7.966	8.386	SF	2.375	2.375
QD90-8M-50	90	D2F	9.023	8.969	-	SF	2.375	2.375
QD112-8M-50	112	D3	11.229	11.175	-	SF	2.375	2.375
QD144-8M-50	144	D3	14.437	14.383	-	E	2.375	2.375
QD192-8M-50	192	D3	19.249	19.195	-	E	2.375	2.375

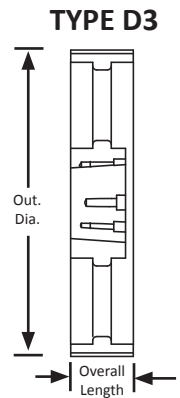
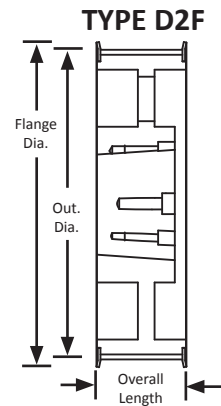
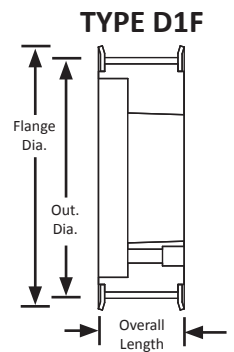
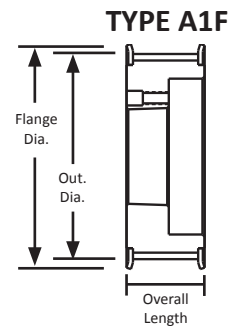

For matching QD® bushings, see page 89.

H SERIES TIMING PULLEYS

8 mm Pitch

For 85 mm Wide Belts

Iron

Black Oxide Plating

QD® Style



Part Number	No. of Teeth	Type	Pitch Dia	Out. Dia	Flange Dia.	Bore	Face Width	Overall Length
QD34-8M-85	34	A1F	3.409	3.355	3.819	SH	3.75	3.75
QD36-8M-85	36	A1F	3.609	3.555	3.937	SH	3.75	3.75
QD38-8M-85	38	A1F	3.81	3.756	4.134	SH	3.75	3.75
QD40-8M-85	40	A1F	4.01	3.956	4.331	SD	3.75	3.75
QD44-8M-85	44	A1F	4.411	4.357	4.764	SD	3.75	3.75
QD48-8M-85	48	A1F	4.812	4.758	5.157	SD	3.75	3.75
QD56-8M-85	56	A1F	5.614	5.56	5.945	SK	3.75	3.75
QD64-8M-85	64	A1F	6.416	6.362	6.772	SK	3.75	3.75
QD72-8M-85	72	A1F	7.218	7.164	7.598	SF	3.75	3.75
QD80-8M-85	80	A1F	8.02	7.966	8.386	SF	3.75	3.75
QD90-8M-85	90	A2	9.023	8.969	-	SF	3.75	3.75
QD112-8M-85	112	A3	11.229	11.175	-	SF	3.75	3.75
QD144-8M-85	144	A3	14.437	14.383	-	E	3.75	3.75
QD192-8M-85	192	A3	19.249	19.195	-	E	3.75	3.75

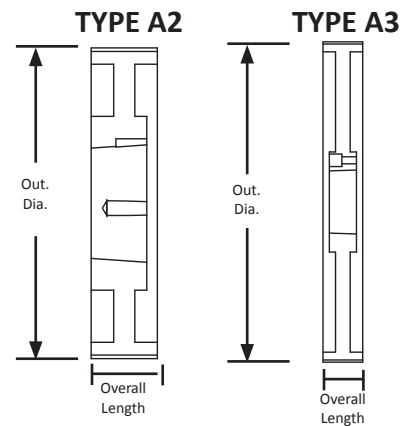
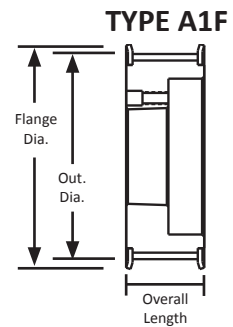

H SERIES TIMING PULLEYS

14 mm Pitch

For 40 mm Wide Belts

Iron

Black Oxide Plating

QD® Style



Part Number	No. of Teeth	Type	Pitch Dia. (in)	Out. Dia. (in)	Flange Dia. (in)	Bore / Bushing	Face Width (in)	Overall Length (in)
QD28-14M-40	28	E1F	4.912	4.802	5.560	SK	2.125	2.750
QD29-14M-40	29	E1F	5.088	4.978	5.560	SK	2.125	2.750
QD30-14M-40	30	D1F	5.263	5.153	6.130	SK	2.125	2.125
QD32-14M-40	32	D1F	5.614	5.504	6.130	SK	2.125	2.125
QD34-14M-40	34	D1F	5.965	5.855	6.500	SK	2.125	2.125
QD36-14M-40	36	D1F	6.316	6.206	6.810	SF	2.125	2.125
QD38-14M-40	38	D1F	6.667	6.557	7.160	SF	2.125	2.125
QD40-14M-40	40	D1F	7.018	6.909	7.500	SF	2.125	2.125
QD44-14M-40	44	D1F	7.720	7.610	8.220	E	2.125	2.125
QD48-14M-40	48	D1F	8.421	8.311	8.940	E	2.125	2.125
QD52-14M-40	52	D1F	9.123	9.013	9.690	E	2.125	2.125
QD56-14M-40	56	D1F	9.825	9.715	10.380	E	2.125	2.125
QD60-14M-40	60	D1F	10.527	10.417	11.060	E	2.125	2.125
QD64-14M-40	64	D2F	11.229	11.119	11.750	E	2.125	2.125
QD68-14M-40	68	D2F	11.930	11.820	12.500	E	2.125	2.125
QD72-14M-40	72	D2F	12.632	12.522	13.190	E	2.125	2.125
QD80-14M-40	80	D2F	14.036	13.925	14.630	E	2.125	2.125
QD90-14M-40	90	D3	15.790	15.680	-	E	2.125	2.125
QD112-14M-40	112	D3	19.650	19.540	-	E	2.125	2.125
QD144-14M-40	144	D3	25.264	25.154	-	E	2.125	2.125

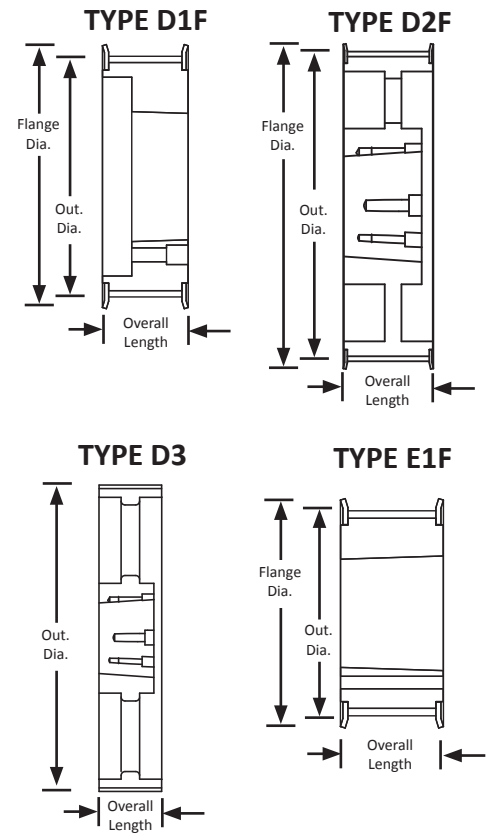

H SERIES TIMING PULLEYS

14 mm Pitch

For 55 mm Wide Belts

Iron

Black Oxide Plating

QD® Style



Part Number	No. of Teeth	Type	Pitch Dia. (in)	Out. Dia. (in)	Flange Dia. (in)	Bore / Bushing	Face Width (in)	Overall Length (in)
QD28-14M-55	28	E1F	4.912	4.802	5.560	SK	2.750	2.750
QD29-14M-55	29	E1F	5.088	4.978	5.560	SK	2.750	2.750
QD30-14M-55	30	A1F	5.263	5.153	6.130	SK	2.750	2.750
QD32-14M-55	32	A1F	5.614	5.504	6.130	SK	2.750	2.750
QD34-14M-55	34	A1F	5.965	5.855	6.500	SK	2.750	2.750
QD36-14M-55	36	A1F	6.316	6.206	6.810	SF	2.750	2.750
QD38-14M-55	38	A1F	6.667	6.557	7.160	SF	2.750	2.750
QD40-14M-55	40	A1F	7.018	6.909	7.500	SF	2.750	2.750
QD44-14M-55	44	D1F	7.720	7.610	8.220	E	2.750	2.750
QD48-14M-55	48	D1F	8.421	8.311	8.940	E	2.750	2.750
QD52-14M-55	52	D1F	9.123	9.013	9.690	E	2.750	2.750
QD56-14M-55	56	D1F	9.825	9.715	10.380	E	2.750	2.750
QD60-14M-55	60	D1F	10.527	10.417	11.060	E	2.750	2.750
QD64-14M-55	64	C1F	11.229	11.119	11.750	F	2.750	2.750
QD68-14M-55	68	D2F	11.930	11.820	12.500	F	2.750	2.750
QD72-14M-55	72	C2F	12.632	12.522	13.190	F	2.750	2.750
QD80-14M-55	80	C2F	14.036	13.925	14.630	F	2.750	2.750
QD90-14M-55	90	D3	15.790	15.680	-	F	2.750	2.750
QD112-14M-55	112	D3	19.650	19.540	-	F	2.750	2.750
QD144-14M-55	144	D3	25.264	25.154	-	F	2.750	2.750
QD168-14M-55	168	D3	29.475	29.365	-	F	2.750	2.750
QD192-14M-55	192	D3	33.686	33.576	-	F	2.750	2.750
QD216-14M-55	216	D3	37.896	37.786	-	F	2.750	2.750

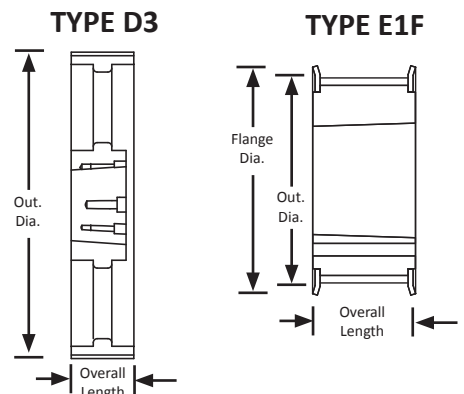
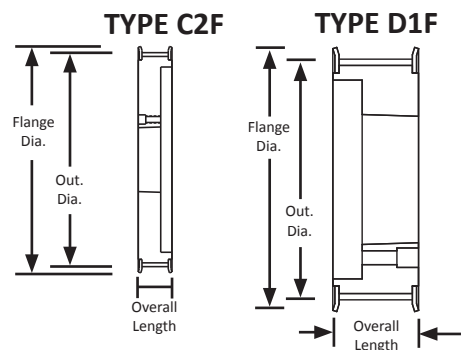
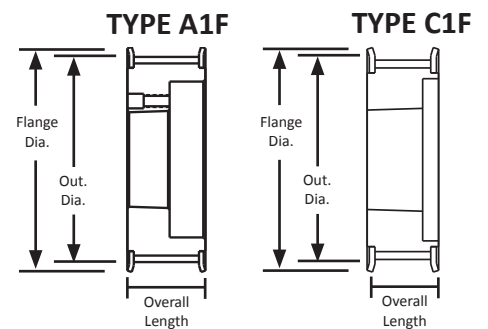

H SERIES TIMING PULLEYS

14 mm Pitch

For 85 mm Wide Belts

Iron

Black Oxide Plating



Part Number	No. of Teeth	Type	Pitch Dia. (in)	Out. Dia. (in)	Flange Dia. (in)	Bore / Bushing	Face Width (in)	Overall Length (in)
28-14M85-6FS13	28	D1F	4.912	4.802	5.560	1.250"	4.000	4.000
29-14M85-6FS13	29	D1F	5.088	4.963	5.560	1.250"	4.000	4.000
30-14M85-6FS13	30	D1F	5.263	5.157	6.130	1.250"	4.000	4.000
QD30-14M-85	30	A1F	5.293	5.157	6.130	SK	4.000	4.000
32-14M85-6FS13	32	D1F	5.614	5.507	6.130	1.250"	4.000	4.000
QD32-14M-85	32	A1F	5.614	5.507	6.130	SK	4.000	4.000
34-14M85-6FS13	34	D1F	5.965	5.858	6.500	1.250"	4.000	4.000
QD34-14M-85	34	A1F	5.965	5.858	6.130	SK	4.000	4.000
QD36-14M-85	36	A1F	6.316	6.206	6.810	SF	4.000	4.000
QD38-14M-85	38	A1F	6.667	6.557	7.160	SF	4.000	4.000
QD40-14M-85	40	A1F	7.018	6.909	7.500	SF	4.000	4.000
QD44-14M-85	44	A1F	7.720	7.610	8.220	E	4.000	4.000
QD48-14M-85	48	A1F	8.421	8.311	8.940	E	4.000	4.000
QD52-14M-85	52	A1F	9.123	9.013	9.690	E	4.000	4.000
QD56-14M-85	56	D1F	9.825	9.715	10.360	F	4.000	4.000
QD60-14M-85	60	D1F	10.527	10.417	11.060	F	4.000	4.000
QD64-14M-85	64	D1F	11.229	11.119	11.750	F	4.000	4.000
QD68-14M-85	68	D2F	11.930	11.820	12.500	F	4.000	4.000
QD72-14M-85	72	D2F	12.632	12.522	13.190	F	4.000	4.000
QD80-14M-85	80	D2F	14.036	13.926	14.630	F	4.000	4.000
QD90-14M-85	90	D3	15.790	15.680	-	F	4.000	4.000
QD112-14M-85	112	D3	19.650	19.540	-	F	4.000	4.000
QD144-14M-85	144	D3	25.264	25.154	-	F	4.000	4.000
QD168-14M-85	168	D3	29.475	29.365	-	J	4.000	4.000
QD192-14M-85	192	D3	33.686	33.576	-	J	4.000	4.000
QD216-14M-85	216	D3	37.786	37.786	-	J	4.000	4.000

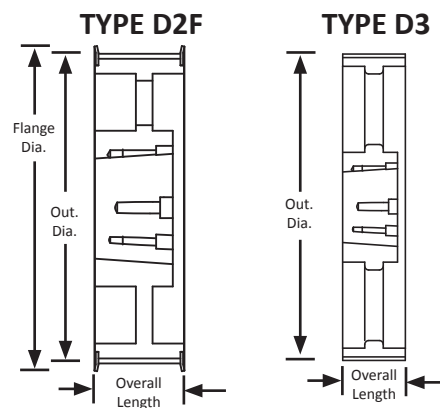
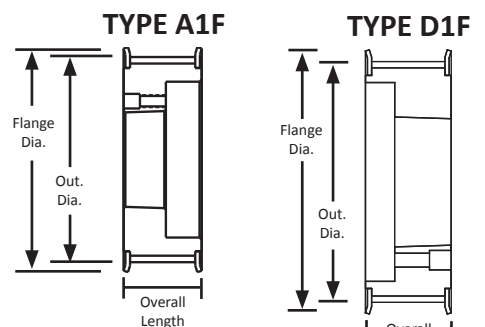

For matching QD® bushings, see page 89.

H SERIES TIMING PULLEYS

14 mm Pitch

For 115 mm Wide Belts

Iron

Black Oxide Plating



Part Number	No. of Teeth	Type	Pitch Dia	Out. Dia	Flange Dia.	Bore/ Bushing	Face Width	Overall Length
28-14M115-6FS13	28	D1F	4.912	4.808	5.560	1.250"	5.250	5.250
29-14M115-6FS13	29	D1F	5.088	4.983	5.560	1.250"	5.250	5.250
30-14M115-6FS13	30	D1F	5.263	5.157	6.130	1.250"	5.250	5.250
QD30-14M-115	30	A1F	5.263	5.157	6.130	SK	5.250	5.250
32-14M115-6FS13	32	D1F	5.614	5.507	6.130	1.250"	5.250	5.250
QD32-14M-115	32	A1F	5.614	5.507	6.130	SK	5.250	5.250
34-14M115-6FS13	34	D1F	5.965	5.858	6.500	1.250"	5.250	5.250
QD34-14M-115	34	A1F	5.965	5.858	6.500	SK	5.250	5.250
36-14M115-6FS13	36	D1F	6.316	6.208	6.810	1.250"	5.250	5.250
QD36-14M-115	36	A1F	6.316	6.208	6.810	SF	5.250	5.250
38-14M115-6FS13	38	D1F	6.667	6.559	7.160	1.250"	5.250	5.250
QD38-14M-115	38	A1F	6.667	6.559	7.160	SF	5.250	5.250
40-14M115-6FS13	40	D1F	7.018	6.909	7.500	1.250"	5.250	5.250
QD40-14M-115	40	A1F	7.018	6.909	7.500	SF	5.250	5.250
QD44-14M-115	44	A1F	7.720	7.610	8.220	E	5.250	5.250
QD48-14M-115	48	A1F	8.421	8.311	8.940	E	5.250	5.250
QD52-14M-115	52	A1F	9.123	9.013	9.690	F	5.250	5.250
QD56-14M-115	56	A1F	9.825	9.715	10.380	F	5.250	5.250
QD60-14M-115	60	A1F	10.527	10.417	11.060	F	5.250	5.250
QD64-14M-115	64	D1F	11.229	11.119	11.750	J	5.250	5.250
QD68-14M-115	68	D1F	11.930	11.820	12.500	J	5.250	5.250
QD72-14M-115	72	D1F	12.632	12.522	13.190	J	5.250	5.250
QD80-14M-115	80	D2F	14.036	13.926	14.630	J	5.250	5.250
QD90-14M-115	90	D2	15.790	15.680	-	J	5.250	5.250
QD112-14M-115	112	D3	19.650	19.540	-	J	5.250	5.250
QD144-14M-115	144	D3	25.264	25.154	-	J	5.250	5.250
QD168-14M-115	168	D3	29.475	29.365	-	M	5.250	5.250
QD192-14M-115	192	D3	33.686	33.576	-	M	5.250	5.250
QD216-14M-115	216	D3	37.896	37.786	-	M	5.250	5.250

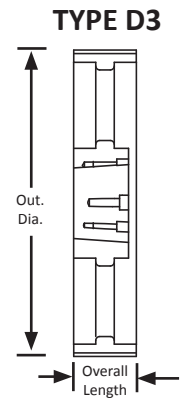
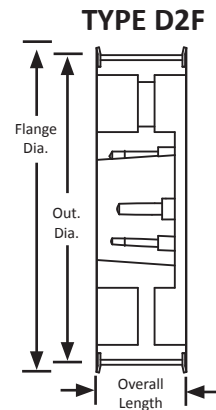
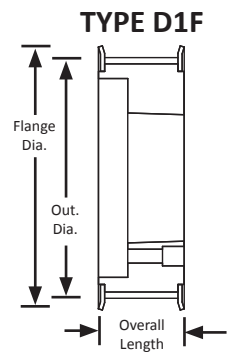
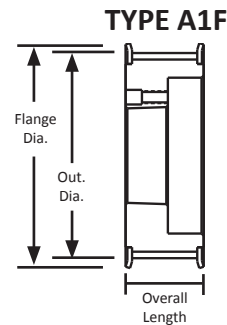

H SERIES TIMING PULLEYS

14 mm Pitch

For 85 mm Wide Belts

Iron

Black Oxide Plating



Part Number	No. of Teeth	Type	Pitch Dia. (in)	Out. Dia. (in)	Flange Dia. (in)	Bore / Bushing	Face Width (in)	Overall Length (in)
36-14M170-6FS16	36	D1F	6.316	6.208	6.810	1.500"	7.375	7.375
38-14M170-6FS16	38	D1F	6.667	6.559	7.160	1.500"	7.375	7.375
40-14M170-6FS16	40	D1F	7.018	6.909	7.500	1.500"	7.375	7.375
44-14M170-6FS16	44	D1F	7.720	7.610	8.220	1.500"	7.375	7.375
QD44-14M-170	44	A1F	7.720	7.610	8.220	E	7.375	7.375
48-14M170-6FS16	48	D1F	8.421	8.311	8.940	1.500"	7.375	7.375
QD48-14M-170	48	A1F	8.421	8.311	8.940	E	7.375	7.375
QD52-14M-170	52	A1F	9.123	9.013	9.690	F	7.375	7.375
QD56-14M-170	56	A1F	9.825	9.715	10.380	F	7.375	7.375
QD60-14M-170	60	A1F	10.527	10.417	11.060	J	7.375	7.375
QD64-14M-170	64	A1F	11.229	11.119	11.750	J	7.375	7.375
QD68-14M-170	68	A1F	11.930	11.820	12.500	J	7.375	7.375
QD72-14M-170	72	A1F	12.632	12.522	13.190	J	7.375	7.375
QD80-14M-170	80	A2F	14.036	13.926	14.630	J	7.375	7.375
QD90-14M-170	90	A2	15.790	15.680	-	J	7.375	7.375
QD112-14M-170	112	A3	19.650	19.540	-	M	7.375	7.375
QD144-14M-170	144	A3	25.264	25.164	-	M	7.375	7.375
QD168-14M-170	168	A3	29.475	29.365	-	M	7.375	7.375
QD192-14M-170	192	A3	33.686	33.576	-	M	7.375	7.375
QD216-14M-170	216	A3	37.896	37.786	-	M	7.375	7.375

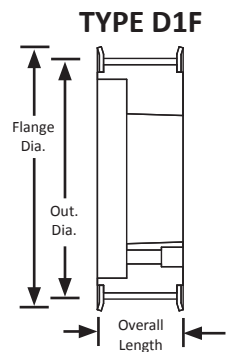
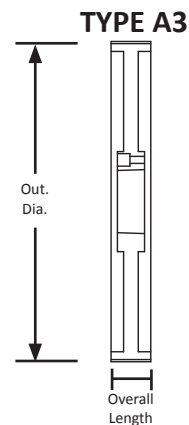
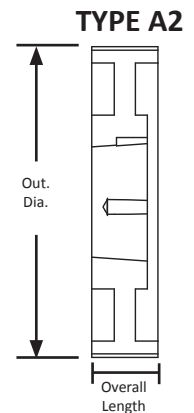
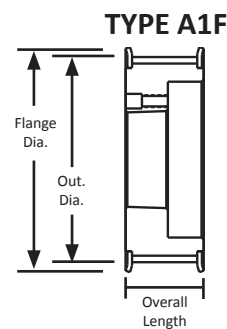



For matching QD® bushings, see page 89.

Safety Precautions

Please read all the warnings!

- Please take all necessary precautions when using our products. Also, please review relevant product catalog and design documents, etc.

Significances of safety precautions are categorized as follows:

Signs	Meanings
 Danger	Imminently causing death or severe injury to the user who misuses products.
 Warning	Possibly causing death or severe injury to the user who misuses products.
 Caution	Possibly causing personal injury or property damage if misused.

Power Transmission Products

Mounting & Operation



Caution

- Do not cut a belt while tension is applied, otherwise the belt may burst out and cause personal injury.
- Make sure the belt is properly set into the pulley groove before use. Improper application of a belt may cause its premature failure or personal injury.
- The belt and the pulley may be extremely hot after the operation. Allow them to cool down sufficiently before touch. Otherwise, you may be burned.

Handling of Used items



Caution

- For the multiple belt drive, always change all belts at the same time. Failure to do so may shorten the service lives of the belts or cause personal injury.

* For all Safety Precautions concerning MITSUBOSHI Belt Products, please refer to MITSUBOSHI Industrial Belt Catalog.

NOTES



MITSUBOSHI BELTING LTD. GROUP

MBL (USA) CORPORATION

601 Dayton Road, Ottawa, IL 61350

Phone: (815) 434-1282 • **Toll Free Call:** 1-877-625-7832 or

1-877-MBL-PTDB (Power Transmission Drive Belt)

Fax: (815) 434-2897 • **Toll Free Fax:** 1-800-782-7625 or 1-800-STARMBL

www.mblusa.com

The information contained in this catalogue is for informational purpose only.

IN NO EVENT SHALL MITSUBOSHI BE LIABLE FOR ANY INDIRECT, SPECIAL, PUNITIVE, INCIDENTAL OR CONSEQUENTIAL DAMAGES OR LOST PROFITS, ARISING OUT OF OR RELATED TO MITSUBOSHI PRODUCTS NOR FOR ANY DAMAGES ARISING DUE TO ANY USE OF MITSUBOSHI PRODUCTS NOT IN CONFORMANCE WITH THE INSTRUCTIONS PROVIDED BY MITSUBOSHI IN THIS CATALOGUE.

MITSUBOSHI SPECIFICALLY DISCLAIMS ANY IMPLIED WARRANTY OF MERCHANT ABILITY OR FITNESS FOR PARTICULAR PURPOSE.